

# INSTALLATION AND OPERATION MANUAL

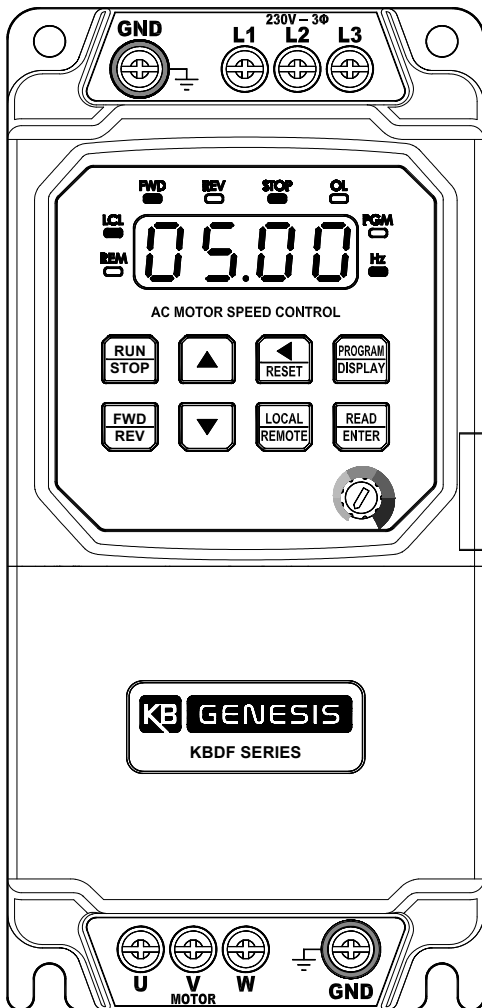
# KBDF SERIES

## DIGITAL AC DRIVE

### IP-20 Enclosure

Rated for 208 – 230 and 400/460 Volt 50 & 60 Hz  
1/8 HP thru 5 HP 3-Phase AC Induction Motors

Operates from 115, 208/230, and 400/460 Volt 50/60 Hz AC Line



This product has been designed in accordance with Underwriters Laboratories, Inc. Standard UL 508C, however, it has not yet been approved.



SEE  
SAFETY  
WARNING  
ON PAGE 9

#### NOTE

This drive is factory set for 60 Hz Motors. For 50 Hz Motors, see Section 2.1, page 7.



Designed and  
Assembled in USA

This Manual Covers Models

**KBDF-13, 23, 23F, 23D, 23P, 14, 24, 24F, 24D, 24P, 16, 27, 27F, 27D, 27P, 29, 42, 43, 45, 48**

The information contained in this manual is intended to be accurate.

However, the manufacturer retains the right to make changes in design, which may not be included herein.



**Automation and Control**

Copyright © 2012  
KB Electronics, Inc.  
(see back cover)

---

**TABLE OF CONTENTS**

---

Section	Page
1 FAMILIARIZING YOURSELF WITH THE DRIVE .....	6
2 IMPORTANT PROGRAMMING INFORMATION .....	7
2.1 50 Hz Motors .....	7
2.2 Motor Current Setting .....	7
3 IMPORTANT APPLICATION INFORMATION .....	8
3.1 Motor with External Fan Cooling .....	8
3.2 Electronic Motor Overload Protection .....	8
4 SAFETY WARNING .....	9
5 INTRODUCTION .....	10
5.1 Standard Features .....	11
5.2 Performance Features .....	12
5.3 Protection Features .....	12
6 DRIVE LAYOUT .....	16
7 MOUNTING .....	18
8 ELECTRICAL CONNECTIONS .....	20
8.1 AC Line Input and Ground .....	22
8.2 AC Line Input Fusing .....	24
8.3 Motor and Ground .....	24
8.4 Remote Operation .....	25
8.4.1 Start/Stop and Forward/Reverse .....	27
8.4.1.1 Automatic Start .....	27
8.4.1.2 2-Wire Start/Stop .....	28
8.4.1.3 3-Wire Start/Stop .....	28
8.4.1.4 Forward/Stop and Reverse/Stop .....	29
8.4.2 Frequency Control .....	30
8.4.2.1 Analog Input .....	30
8.4.2.1.1 Voltage Following .....	31
8.4.2.1.2 Current Following .....	32
8.4.2.2 Remote Main Speed Potentiometer .....	32
8.4.2.3 Up/Down Frequency Control .....	34
8.4.2.4 Preset Frequency Control .....	37
8.4.2.5 Modbus Communication .....	38
8.4.3 Multi-Function Input Terminals* .....	39
*For NPN and PNP Transistor Circuits, see Appendix E, on page 70.	
8.4.3.1 Reset .....	39
8.4.3.2 External Fault .....	39
8.4.3.3 Accel/Decel #2 .....	40
8.4.4 Multi-Function Output Relay .....	41
8.4.5 Analog Output .....	42
9 HIGH VOLTAGE DIELECTRIC WITHSTAND TESTING (HI-POT TEST) .....	43
10 DRIVE OPERATION .....	44
10.1 Start-Up Procedure .....	44
10.2 Local/Remote Operation .....	44
10.3 Keypad Description .....	44
10.4 Flow Charts for Important Programming Functions .....	45
11 4-DIGIT DISPLAY READOUT CODES .....	52
12 PROGRAMMABLE FUNCTION LIST .....	54
APPENDIX A: Optional IODF Input/Output Multi-Function Expansion Module .....	64
APPENDIX B: Optional DIDF RS-232 and RS-485 Modbus RTU Communication Module .....	67
APPENDIX C: Optional Memory Module .....	68
APPENDIX D: Optional Dynamic Brake Module (Case "B" Drives Only) .....	69
APPENDIX E: Multi-Function Input Terminals with NPN and PNP Transistor Circuits .....	70
LIMITED WARRANTY .....	Back Cover

---

**TABLE OF CONTENTS (CONTINUED)**

---

<b>Table</b>	<b>Page</b>
1 Options .....	13
2 General Performance Specifications .....	14
3 Electrical Ratings .....	15
4 Descriptions of 4-Digit Display, LEDs, Keys, and Potentiometer .....	17
5 Drive Terminal Block Wire and Tightening Torque Specifications .....	22
6 Drive Multi-Function Input Terminal, Function, and Factory Code Assignment .....	25
7 Drive Input and Output Connections .....	26
8 Preset Frequency Selection .....	37
9 Drive Multi-Function Output Relay "Run" and "Fault" Operating Modes .....	41
10 Digital Readout Codes .....	52, 53
11 IODF Multi-Function Output Relay "Run" and "Fault" Operating Modes .....	64
12 IODF Input and Output Connections .....	65
13 IODF Terminal Block Wire and Tightening Torque Specifications .....	65
14 IODF Multi-Function Input Terminal, Function, and Factory Code Assignment .....	66

<b>Figure</b>	<b>Page</b>
1 Description of 4-Digit Display, LEDs, Keys, and Main Speed Potentiometer .....	6
2 Maximum Allowed Motor Torque vs. Speed .....	8
3 Drive Layout .....	16
4 Case "A" Drives Mechanical Specifications .....	18
5 Case "B" Drives Mechanical Specifications .....	19
6 General Connection Diagram .....	21
7 Models KBDF-13, 14, 16 AC Line Input and Ground Connections .....	22
8 Models KBDF-23D, 24D, 27D AC Line Input and Ground Connections .....	23
9 Models KBDF-23, 23F, 24, 24F, 27, 27F AC Line Input and Ground Connections .....	23
10 Models KBDF-23P, 24P AC Line Input and Ground Connections .....	23
11 Models KBDF-27P, 29 AC Line Input and Ground Connections .....	23
12 Models KBDF-42, 43, 45, 48 AC Line Input and Ground Connections .....	24
13 Motor and Ground Connections .....	24
14 Automatic Start Connections and Drive Programming .....	27
15 2-Wire Start/Stop Connections and Drive Programming .....	28
16 3-Wire Start/Stop Connections and Drive Programming .....	28
17 Forward/Stop and Reverse/Stop Connections and Drive Programming .....	29
18 Analog Input Signal Gain and Offset with Positive Slope (Low-to-High Signal) .....	30
19 Analog Input Signal Gain and Offset with Negative Slope (High-to-Low Signal) .....	30
20 Analog Input Jumper J2 Settings .....	31
21 Voltage Following Connections, Jumper J2 Settings, and Drive Programming .....	31
22 Current Following Connections, Jumper J2 Settings, and Drive Programming .....	32
23 Unidirectional Remote Main Speed Potentiometer with Start/Stop Connections and Drive Programming .....	33
24 Bidirectional Remote Main Speed Potentiometer with Start/Stop Connections, Jumper J2 Settings, and Drive Programming .....	33
25 Unidirectional Remote Main Speed Potentiometer with Forward/Reverse Connections, Jumper J2 Settings, and Drive Programming .....	34
26 Unidirectional Up/Down Frequency Control with 2-Wire Start/Stop Connections, Jumper J2 Settings, and Drive Programming .....	35
27 Bidirectional Up/Down Frequency Control Connections and Drive Programming .....	36
28 Unidirectional Preset Frequency Selection with 2-Wire Start/Stop Connections and Drive Programming .....	38
29 Unidirectional Preset Frequency Selection with 3-Wire Start/Stop Connections and Drive Programming .....	38
30 Reset Connections and Drive Programming .....	39
31 External Fault Connections and Drive Programming .....	40

---

**TABLE OF CONTENTS (CONTINUED)**

---

<b>Figure</b>	<b>Page</b>
32 Accel/Decel #2 Connections and Drive Programming .....	41
33 Multi-Function Output Relay Connections.....	41
34 Analog Output Connections and Drive Programming .....	42
35 Analog Output Gain.....	42
36 Typical Hi-Pot Test Setup .....	43
37 Flow Chart to Program Motor Current from 6.7 Amps to 5.5 Amps .....	45
38 Flow Chart to Change Set Frequency from 5.00 Hz TO 43.21 Hz.....	46
39 Flow Chart to Program Accel Time from 1.5 Seconds to 120 Seconds .....	47
40 Flow Chart to Program the Drive to Display Motor RPM.....	48
41 Flow Chart to Program the Drive to Display Custom Units "012.0".....	49
42 Flow Chart Showing Motor Current, Motor Voltage, and Bus Voltage Added to Basic Display .....	50
43 Flow Chart to Program the Drive for Remote Operation Only.....	50
44 Flow Chart to Program the Drive for 50 Hz Motors .....	51
45 Function No. Description.....	54
46 IODF Layout.....	66
47 DIDF Layout.....	67
48 Memory Module .....	68
49 Dynamic Brake Module Connection (Case "B" Drives Only) .....	69
50 Sinking Mode Using NPN Transistors with Internal Power Supply Connections and Jumper J1 Setting .....	70
51 Sinking Mode Using NPN Transistors with External Power Supply Connections and Jumper J1 Setting .....	70
52 Sourcing Mode Using PNP Transistors with Internal Power Supply Connections and Jumper J1 Setting .....	70
53 Sourcing Mode Using PNP Transistors with External Power Supply Connections and Jumper J1 Setting .....	70

**ITEMS INCLUDED IN THIS PACKAGE**

KBDF Drive, Installation and Operation Manual, Mounting Template, and Warranty Registration Card.

## **UL NOTICE**

### **115 Volt Drives**

Suitable for use on a circuit capable of delivering not more than  
5 kA RMS symmetrical Amperes.  
115 Volts maximum.

Use copper conductors rated 75 °C.

Suitable for operation in a maximum surrounding air temperature of 40 °C.

### **230 Volt Drives**

Suitable for use on a circuit capable of delivering not more than  
5 kA RMS symmetrical Amperes.  
230 Volts maximum.

Use copper conductors rated 75 °C.

Suitable for operation in a maximum surrounding air temperature of 40 °C.

### **460 Volt Drives**

Suitable for use on a circuit capable of delivering not more than  
5 kA RMS symmetrical amperes.  
460 Volts maximum.

Use copper conductors rated 75 °C.

Suitable for operation in a maximum surrounding air temperature of 40 °C.

# 1 FAMILIARIZING YOURSELF WITH THE DRIVE

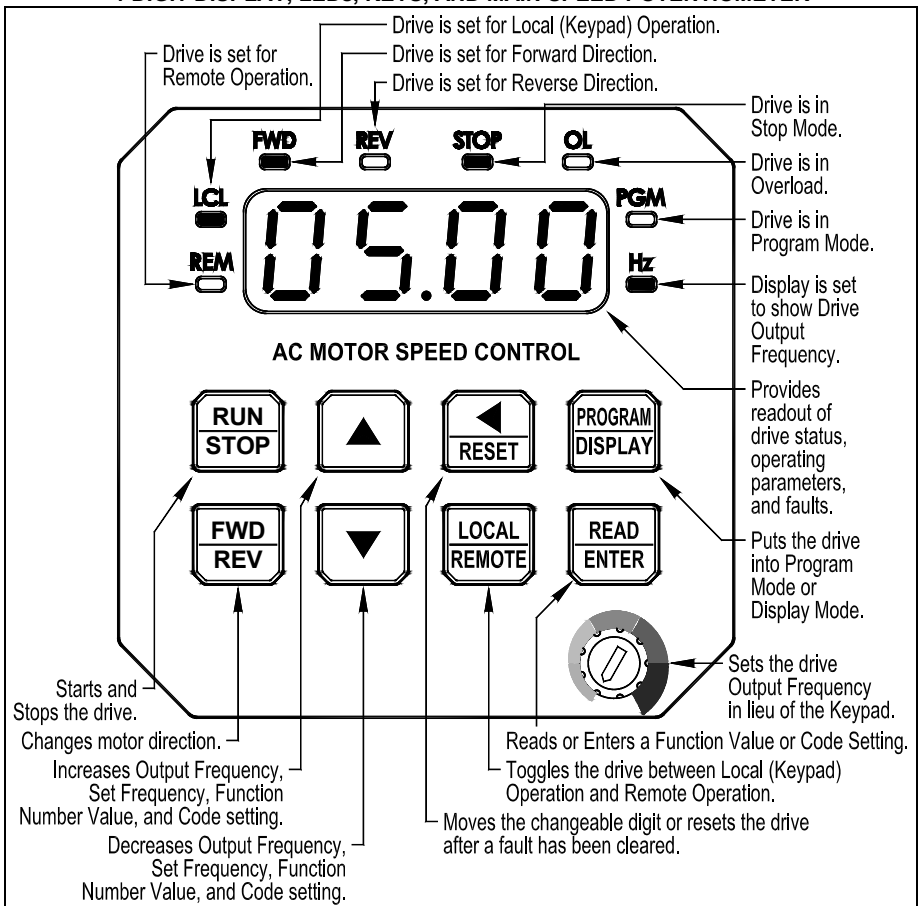
To get acquainted with the operation and programming, the drive does not need to be installed into the application or have a motor connected. In addition, drives rated for 3-phase AC Line input, can be operated with only 1-phase.

To better understand the programmable features of the drive, review the Programmable Function List in Section 12, on pages 54 – 63.

To familiarize yourself with the input/output features of the drive, review the Remote Operations section, on pages 25 – 43.

To facilitate the programming procedures of the drive, review the flow charts in Section 10.4, on pages 45 – 51.

**FIGURE 1**  
**DESCRIPTION OF**  
**4-DIGIT DISPLAY, LEDs, KEYS, AND MAIN SPEED POTENTIOMETER**



---

## **2 IMPORTANT PROGRAMMING INFORMATION**

---

### **2.1 50 Hz MOTORS**

This drive has been factory programmed to operate 60 Hz motors. For 50 Hz motor operation, set Function 0.00 to "0001" (50 Hz Motors). See Flow Chart (Figure 44), on page 51.

### **2.2 MOTOR CURRENT SETTING**

The motor current is factory set to the maximum drive rating, as shown in Table 3, on page 15. In order for the Motor Overload Protection to operate properly, the drive must be reprogrammed to the actual Motor Nameplate Current (see Function 0.01). Do not exceed the drive's maximum current rating. See Flow Chart (Figure 37), on page 45.

#### **Model KBDF-27D:**

- With 208/230 Volt 50/60 Hz AC Line input, the maximum current rating is 6.7 Amps (2 HP (1.5 kW)). This is the factory setting of motor current.
- With 115 Volt 50/60 Hz AC Line input, the maximum current rating is 5.5 Amps (1½ HP (1.13 kW)).

#### **Model KBDF-29:**

- With 208/230 Volt 50/60 Hz 3-phase AC Line input, the maximum current rating is 9.0 Amps (3 HP (2.25 kW)).
- With 208/230 Volt 50/60 Hz 1-phase AC Line input, the maximum current rating is 6.7 Amps (2 HP (1.5 kW)).

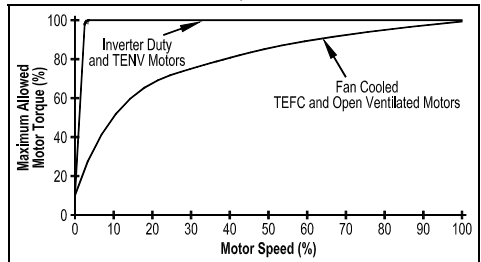
### 3 IMPORTANT APPLICATION INFORMATION

#### 3.1 MOTOR WITH EXTERNAL FAN COOLING

Most totally enclosed fan-cooled (TEFC) and open ventilated 3-phase AC induction motors will overheat if used beyond a limited speed range at full torque. Therefore, it is necessary to reduce motor load as speed is decreased. See Figure 2.

**Note:** Some fan-cooled motors can be used over a wider speed range. Consult the motor manufacturer for details.

**FIGURE 2  
MAXIMUM ALLOWED  
MOTOR TORQUE VS. SPEED**



Inverter duty and most Totally Enclosed Non-Ventilated (TENV) motors can provide full rated torque over an extended speed range without overheating.

**⚠** It is recommended that the drive be used with Inverter Duty or TENV motors.

**⚠ WARNING!** Some motors have low speed characteristics, which cause overheating and winding failure under light load or no load conditions. If the motor is operated in this manner for an extended period of time, it is recommended that the unloaded motor current be checked from 2 – 15 Hz (60 – 450 RPM) to ensure motor current does not exceed the nameplate rating. If the motor current exceeds the nameplate rating, the Boost value may have to be decreased (see Function 3.14). **Do not use motor if the motor current exceeds the nameplate rating.**

#### 3.2 ELECTRONIC MOTOR OVERLOAD PROTECTION

The drive contains Modified  $I^2t$  Overload Protection (UL approved as an overload protector for motors). Part of this function consists of a Current Limit (CL) circuit, which limits the drive current to a preset level of 160% of the Motor Nameplate Rated Current setting. **The factory setting for motor nameplate current is the drive rated current, which must be set to the actual motor nameplate current (see Important Application Information (Section 2.2), on page 7). See Table 3, on page 15. See Function 0.01, on page 55.**

Standard  $I^2t$  is undesirable because it causes nuisance tripping. It allows a very high motor current to develop and will turn the drive off after a short period of time. KB's RMS Current Limit Circuit avoids this nuisance tripping while providing maximum motor protection.

If the motor is overloaded to 120% of the Motor Nameplate Rated Current, the  $I^2t$  Timer starts. If the motor continues to be overloaded at the 120% level, the timer will shut down the drive after 30 minutes. If the motor is overloaded to 160% of full load, the drive will trip in 6 seconds.



---

## 4 SAFETY WARNING

---

### Definition of Safety Warning Symbols



**Electrical Hazard Warning Symbol:** Failure to observe this warning could result in electrical shock or electrocution.



**Operational Hazard Warning Symbol:** Failure to observe this warning could result in serious injury or death.



This product should be installed and serviced by a qualified technician, electrician, or electrical maintenance person familiar with its operation and the hazards involved. Proper installation, which includes electrical connections, fusing or other current protection, and grounding, can reduce the chance of electrical shocks, and/or fires, in this product or products used with this product, such as electric motors, switches, coils, solenoids, and/or relays. Do not use this drive in an explosion-proof application. Eye protection must be worn and insulated adjustment tools must be used when working with drive under power. This product is constructed of materials (plastics, metals, carbon, silicon, etc.) which may be a potential hazard. Proper shielding, grounding, and filtering of this product can reduce the emission of radio frequency interference (RFI) which may adversely affect sensitive electronic equipment. It is the responsibility of the equipment manufacturer and individual installer to supply this Safety Warning to the ultimate end user of this product. (SW 1/2006)

The drive contains electronic Start/Stop circuits, which can be used to start and stop the drive. However, these circuits are never to be used as safety disconnects since they are not fail-safe. Use only the AC Line for this purpose.

Be sure to read and follow all instructions carefully. Fire and/or electrocution can result due to improper use of this product.



This product complies with all CE directives pertinent at the time of manufacture. Contact our Sales Department for Declaration of Conformity. Installation of a CE approved RFI filter is required. See RFI Filters & Chokes Selection Guide D-321 (Part No. A42027) for the selection of filters to meet the Industrial or Residential Standard. Additional shielded cable and/or AC Line cables may be required.

---

## 5 INTRODUCTION

---

Thank you for purchasing the KBDF Digital AC Drive. KB Electronics, Inc. is committed to providing total customer satisfaction by providing quality products that are easy to install and operate.

The KBDF Series of Digital AC Drives are housed in IP-20 enclosures. They are designed to operate 1/8 thru 5 HP 208 – 230 and 400/460 Volt 50 & 60 Hz 3-phase AC and 1-phase PSC induction motors.<sup>1</sup> Flux Vector Control provides high torque, low noise, and excellent load regulation over a wide speed range. Adjustable Linear Acceleration and Deceleration make the drive suitable for soft-start applications.

Due to its user-friendly design and simple to use and understand instruction manual, the KBDF is easy to install and operate. Setting the drive to specific applications is accomplished using the Multi-Function Keypad, which provides easy operation and programming of the drive. To facilitate programming, all similar functions are presented in common groups. For more advanced programming, PC based Drive-Link™ software is available.

The 4-Digit Display provides readout of drive operating parameters and programming functions and displays Output Frequency, Motor RPM, Output Current, Output Voltage, Bus Voltage, Function Codes and Values, Fault Codes, and Custom Units.

The 8 LEDs provide indication of the drive's status and operating mode. When used with process control, the Local/Remote Key can be used to switch from process control to manual control if a process fault occurs.

The on-board memory can store up to 4 programs and the optional Memory Module can store an additional 4 programs for cloning and archiving.

Main features include adjustable RMS Current Limit and I<sup>2</sup>t Motor Overload Protection.<sup>2</sup> Power Start™ delivers over 200% motor torque to ensure startup of high frictional loads and programmable Injection Braking provides rapid motor stop. Electronic Inrush Current Limit (EICL™) eliminates harmful AC Line inrush current, allowing the drive to be AC Line switched. A Multi-Function Output Relay is provided, which can be used to turn on or off equipment or to signal a warning if the drive is put into various modes of operation. The drive also contains AC Line Phase Loss Protection.<sup>3</sup> The drive is suitable for machine or variable torque (HVAC) applications.

For Remote Operation, a removable cover allows access to Multi-Function Input Terminals, Analog Inputs/Outputs, and Multi-Function Output Relay Contacts. The Potentiometer can be used to adjust motor speed in lieu of the built-in keypad.

Optional accessories include IODF Input/Output Multi-Function Expansion Module, DIDF RS-232 and RS-485 Modbus RTU Communication Module, Plug-In Memory Module and PC Windows® based programming software.

**Notes:** 1. PSC motor operation requires OEM software – contact our SalesDepartment. 2. UL approved as an electronic overload protector for motors. 3. Models KBDF-23P, 24P, 27P, 29, 42, 43, 45, 48 contain AC line Phase Loss Protection.

## 5.1 STANDARD FEATURES

- **Simplified Programming:** Programmable parameters are organized into easy-to-understand intuitive groups. Factory programming available.
- **Local/Remote Operation:** When used with process control, the Local/Remote Key can be used to switch from process control to manual control if a process fault occurs.
- **Built-In EMC Filter<sup>1</sup>:** Complies with CE Council Directive 89/336/EEC Class A Industrial Standard. Reduces the footprint and cost compared to an external filter. See Note 1.
- **Memory Module<sup>2</sup>:** The optional Memory Module can store up to 4 programs for cloning and archiving. The drive can also store up to 4 programs.
- **Contactors Style Feed-Throughs:** Provides top entry AC power connections and bottom entry motor connections. Space saving design easily replaces contactors and provides simplified panel wiring and installation.
- **Current and Torque Limit:** Current and torque limiting in motoring and braking quadrants. Automatic extending of Accel and Decel eliminates tripping caused by rapid acceleration and deceleration of high inertial loads. Spin Start operation catches a spinning load and allows a smooth return to the set motor speed.
- **4-Digit Display, 8 status LEDs, and Easy-to-Use Multi-Function Keypad:** Provides readout of drive operating parameters and programming functions, indication of drive status and operating modes.
- **Inputs/Outputs:** 7 Multi-Function Inputs with sink or source mode control logic, 2 Analog Inputs, 2 Multi-Function Output Relays, 1 Analog Output, External Power Supply Input. All control inputs are isolated from the AC Line. 7 Preset Frequencies. Remote Start/Stop and Forward/Reverse Control. NPN or PNP Inputs can be used for sinking or sourcing. Some features require the optional IODF Input/Output Multi-Function Expansion Module.
- **Built-In Potentiometer:** Adjusts set motor speed in lieu of the keypad.
- **Custom Programming for OEM Applications:** Provides out-of-the-box operation.

**Notes:** 1. Models KBDF-23F, 24F, 27F contain a built-in Class A RFI (EMI) AC Line Filter.  
2. Optional Accessory.

## 5.2 PERFORMANCE FEATURES

- **High Performance Sensorless Flux Vector Control with Static Auto Tuning:** Provides excellent speed regulation with high torque loads throughout the entire speed range. Auto energy savings at light loads. Smooth motor torque.
- **Library of Advanced Algorithms:** Custom programming and PLC functions for OEM applications.
- **Power Start™:** Provides more than 200% starting torque, which ensures startup of high frictional loads.
- **Speed Range:** Full torque control over a 50:1 speed range.
- **Built-In PID with Sleep/Wake and Inverse Functions:** Control loop for constant process control of flow, pressure, level, and temperature. Requires optional IODF Input/Output Multi-Function Expansion Module.
- **Serial Communication:** Setup and control via RJ45 Modbus RTU port provides a low-cost networking solution. D1DF required.
- **GFCI Operation:** Tripless operation with GFCIs. (May cause increased audible motor noise.)

## 5.3 PROTECTION FEATURES

- **Motor Overload ( $I^2t$ ) with RMS Current Limit:** Provides motor overload protection which prevents motor burnout and eliminates nuisance trips. UL approved as an electronic overload protector for motors.
- **Electronic Inrush Current Limit (EICL™):** Eliminates harmful inrush AC Line current during startup and allows rapid start with AC Line.
- **Short Circuit:** Shuts down the drive if a short circuit occurs at the motor (phase-to-phase).
- **AC Line Phase Loss Protection:** Shuts down the drive if one of the AC Line input phases is disconnected. Models KBDF-23P, 24P, 27P, 29, 42, 43, 45, 48 only.
- **Undervoltage and Overvoltage:** Shuts down the drive if the AC Line input voltage goes below or above the operating range.
- **MOV Input Transient Suppression.**
- **Microcontroller Self Monitoring and Auto-Reboot.**

**TABLE 1  
OPTIONS**

Option	Part No.	Description
IODF Input/Output Multi-Function Expansion Module	9646	Provides additional input/output and Multi-Function Relay. Increases the functionality of the standard input/output of the drive.
DIDF RS-232 and RS-485 Modbus RTU Communication Module	9647	Allows direct communication between the drive and Modbus RTU protocol. Uses RS-232 and RS-485 Modbus RTU Communication Module. (Required for Drive-Link™.)
Memory Module	9634	The optional plug-in memory module can store up to 4 programs for cloning and archiving. This is in addition to the (4) on-board programs.
Dynamic Brake Module	XXXX	Provides dynamic braking of the motor. Externally mounted. Case "B" drives only.
Drive-Link™ Programming Kit	XXXX	PC Windows® based programming software. Includes DIDF Modbus Communication Module
Custom Programming for OEMs	—	Our Engineering staff will evaluate your application and provide a pre-programmed drive ready to use out-of-the-box. The design can incorporate PLC functions, torque control, multi-speed, and PID operation. <i>Contact our Sales Department.</i>

**TABLE 2**  
**GENERAL PERFORMANCE SPECIFICATIONS**

<b>Description</b>	<b>Specification</b>	<b>Factory Setting</b>
115 Volt AC Line Input Operating Range (Volts AC, 50/60 Hz)	115 (± 15%)	—
208/230 Volt AC Line Input Operating Range (Volts AC, 50/60 Hz)	208 (-15%) / 230 (+15%)	—
400/460 Volt AC Line Input Operating Range (Volts AC, 50/60 Hz)	380 (-15%) – 460 (+15%)	—
Maximum Load (% of Current Overload for 2 Minutes)	150	—
Switching Frequency (kHz)	8, 10, 12, 14, 16	8
Voltage Following Signal Input Range (Volts DC)	0 – ±5, 0 ±10	0 – 5
Current Following Signal Input Range (mA DC)	4 – 20, 0 – 20	—
PWM Following Signal Input Range (kHz / % Duty Cycle)	0.15 – 1 / 0 - 100	—
Analog Output (Volts DC)	0 – 5	—
Output Frequency Resolution (Hz)	0.06	—
Minimum Operating Frequency at Motor (Hz)	0.3	—
Acceleration Time (Seconds)	0.1 – 180.0	1.5
Deceleration Time (Seconds)	0.3 – 180.0	1.5
Speed Range (Ratio)	50:1	—
Speed Regulation (30:1 Speed Range, 0 – Full Load) (% Base Speed) <sup>1</sup>	2.5	—
Overload Protector Trip Time for Stalled Motor (Seconds)	6	—
115 Volt AC Line Input Undervoltage/Overvoltage Trip Points (± 5%) (Volts AC) <sup>2</sup>	76 – 141	—
208/230 Volt AC Line Input Undervoltage/Overvoltage Trip Points (± 5%) (Volts AC) <sup>2</sup>	151 – 282	—
400/460 Volt AC Line Input Undervoltage/Overvoltage Trip Points (± 5%) (Volts AC) <sup>2</sup>	302 / 567	—
Multi-Function Relay Output Contact Rating (Amps at 30 Volts DC, 125 Volts AC, 250 Volts AC)	1, 0.5, 0.25	—
Operating Temperature Range (°C / °F)	0 – 40 / 32 – 104	—
Operating Humidity Range (% Relative, Non-Condensing)	0 – 95	—
Storage Temperature (°C / °F)	-25 – +85 / -13 – +185	—

**Notes:** 1. Dependent on motor performance. 2. Do not operate the drive outside the specified AC Line input voltage operating range.

**TABLE 3  
ELECTRICAL RATINGS**

Model No.	Part No.	Maximum Horsepower (HP (kW))	AC Line Input			Fuse or Circuit Breaker Rating (Amps AC)	Output		Net Wt.		Case Size <sup>3</sup>
			Volts AC (50/60 Hz)	Phase (Φ)	Maximum Current (Amps AC)		Maximum Voltage (Volts AC)	Maximum Continuous Load Current (RMS Amps/Phase)	lbs	kg	
KBDF-13	9623	0.5 (0.37)	115	1	11	15	230	2.4			A
KBDF-23	9688	0.5 (0.37)	208/230	1	7	10	230	2.4			
KBDF-23F <sup>1</sup>	9691	0.5 (0.37)	208/230	1	7	10	230	2.4			
KBDF-23D	9673	0.5 (0.37)	115	1	11	15	230	2.4	2.2	1.00	
			208/230	1	7	10					
KBDF-23P <sup>2</sup>	9694	0.5 (0.37)	208/230	3	3.1	10	230	2.4			
KBDF-14	9624	1 (0.75)	115	1	16	20	230	4.0			
KBDF-24	9689	1 (0.75)	208/230	1	10	15	230	4.0			
KBDF-24F <sup>1</sup>	9692	1 (0.75)	208/230	1	10	15	230	4.0			
KBDF-24D	9674	1 (0.75)	115	1	16	20	230	4.0	2.7	1.24	
			208/230	1	10	15					
KBDF-24P <sup>2</sup>	9695	1 (0.75)	208/230	3	4.8	10	230	4.0			
KBDF-16 <sup>4</sup>	9625	1.5 (1.13)	115	1	22	25	230	5.5			
KBDF-27 <sup>4</sup>		2 (1.5)	208/230	1	15	20	230	6.7			
KBDF-27F <sup>1,4</sup>		2 (1.5)	208/230	1	15	20	230	6.7			
KBDF-27D <sup>4</sup>	9675	1.5 (1.13)	115	1	22	25	230	5.5	2.8	1.27	
		2 (1.5)	208/230	1	15	20	230	6.7			
KBDF-27P <sup>2,4</sup>		2 (1.5)	208/230	1	15	20	230	6.7			
				3	8.7	15	230				
KBDF-29 <sup>2,4</sup>		2 (1.5)	208/230	1	15	20	230	6.7			
		3 (2.25)	208/230	3	10.8	15	230	9.0			
KBDF-42 <sup>2,4</sup>		1 (0.75)	400/460	3	2.6	5	400/460	2.0			
KBDF-43 <sup>2</sup>		2 (1.5)	400/460	3	3.8	5	400/460	3.3			
KBDF-45 <sup>2,4</sup>		3 (2.25)	400/460	3	5.3	10	400/460	4.6			
KBDF-48 <sup>2,4</sup>		5 (3.75)	400/460	3	9.6	15	400/460	8.3			

**Notes:** 1. Models KBDF-23F, 24F, 27F contain a built-in Class A RFI (EMI) AC Line Filter.  
2. Models KBDF-23P, 24P, 27P, 29, 42, 43, 45, 48 contain AC Line Phase Loss Protection.  
3. See Figures 4 and 5, on pages 18 and 19, for the mechanical specifications. 4. Models KBDF-16, 27, 27D, 27F, 27P, 29, 42, 45, 48 contain a built-in cooling fan.

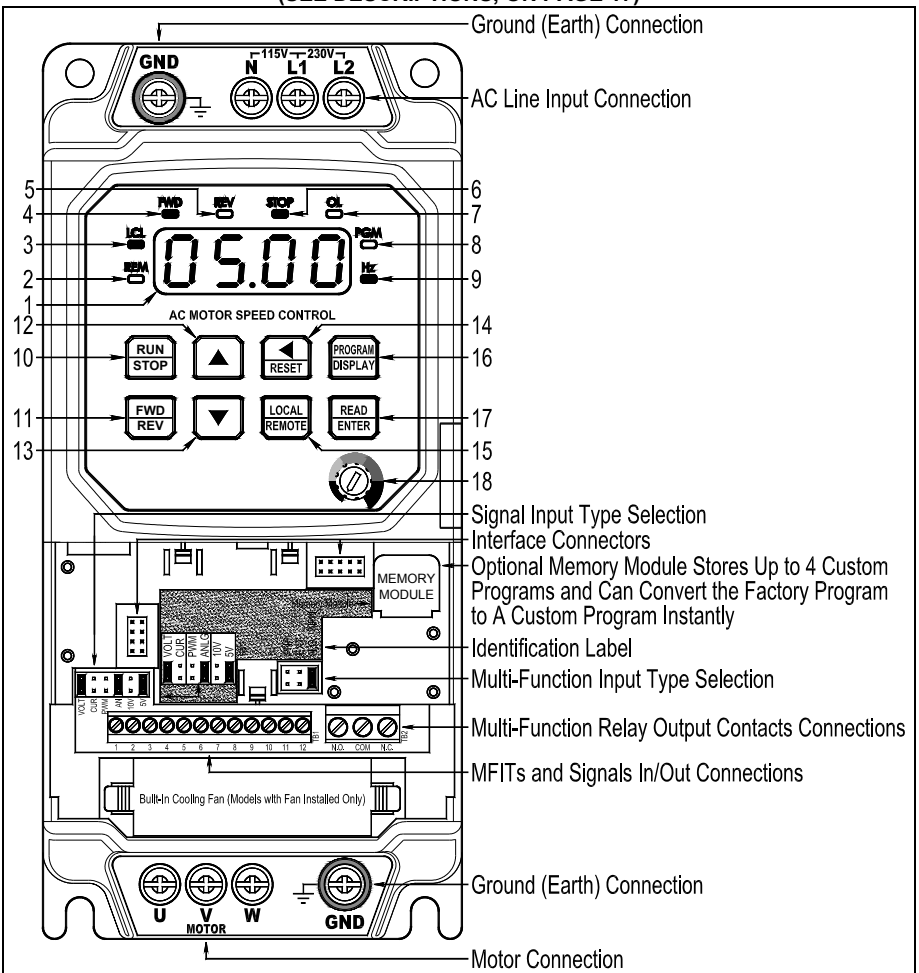
## 6 DRIVE LAYOUT

See Figure 3 for the Drive Layout. See Table 4, on page 17, for description of the Keypad, 4-Digit Display, LEDs, and Potentiometer.

The drive contains 8 LEDs to provide indication of the drive's status and operating mode (REM, LCL, FWD, REV, STOP, OL, PGM, Hz). The Keypad is used for Local Operation of the drive. For Remote Operation see Function Group 2, on page 57. To operate the drive using the Potentiometer, set Function 2.00 to "0001".



















**WARNING!** Do not depend on the LEDs or the 4-Digit Display to no longer be illuminated as a guaranteed power off condition. Be sure that the main power switch or circuit breaker is in the "OFF" position before servicing the drive.

**FIGURE 3**  
**DRIVE LAYOUT**  
 (SHOWN WITH FRONT COVER REMOVED)  
 (SEE DESCRIPTIONS, ON PAGE 17)





**TABLE 4**  
**DESCRIPTIONS OF 4-DIGIT DISPLAY, LEDs, KEYS, AND POTENTIOMETER**

No.	Feature	Description
1		<b>4-Digit Display:</b> Provides readout of drive status, operating parameters, and faults.
2		<b>REM LED:</b> Indicates that the drive is set for Remote Operation.
3		<b>LCL LED:</b> Indicates that the drive is set for Local (Keypad) Operation.
4		<b>FWD LED:</b> Indicates that the drive is set for Forward Direction.
5		<b>REV LED:</b> Indicates that the drive is set for Reverse Direction.
6		<b>STOP LED:</b> Indicates that the drive is in Stop Mode.
7		<b>OL LED:</b> Indicates that the drive is in Overload.
8		<b>PGM LED:</b> Indicates that the drive is in Program Mode.
9		<b>Hz LED:</b> Indicates that the display is set to show Drive Output Frequency (in Hz).
10		<b>RUN / STOP Key:</b> Starts and Stops the drive.
11		<b>FWD/REV Key:</b> Changes motor direction.
12		<b>Up Key:</b> Increases Output Frequency, Set Frequency, Function Number Value, and Code setting.
13		<b>Down Key:</b> Decreases Output Frequency, Set Frequency, Function Number Value, and Code setting.
14		<b>Left Shift / Reset Key:</b> Moves the changeable digit or Resets the drive after a fault has cleared.
15		<b>LOCAL / REMOTE Key:</b> Used to toggle between Local (Keypad) Operation or Remote Operation. When in Local (Keypad) Operation, the LCL LED will remain illuminated. When in Remote Signal Operation, the REM LED will flash 1 second on and 1 second off.
16		<b>PROGRAM / DISPLAY Key:</b> Puts the drive into Program Mode or Display Mode. If pressed while Set Frequency is displayed, the previously entered Function Number will be shown. If pressed while Function Number is displayed, the Set Frequency will be shown. When more than one display function is enabled, the key is used to toggle between displays.
17		<b>READ / ENTER Key:</b> Reads or Enters a Function Value or Code Setting.
18		<b>Potentiometer:</b> Sets the Drive Output Frequency in lieu of the Keypad. To change the Keypad for Potentiometer Operation, set Function 2.00 to code "0001".

## 7 MOUNTING INSTRUCTIONS

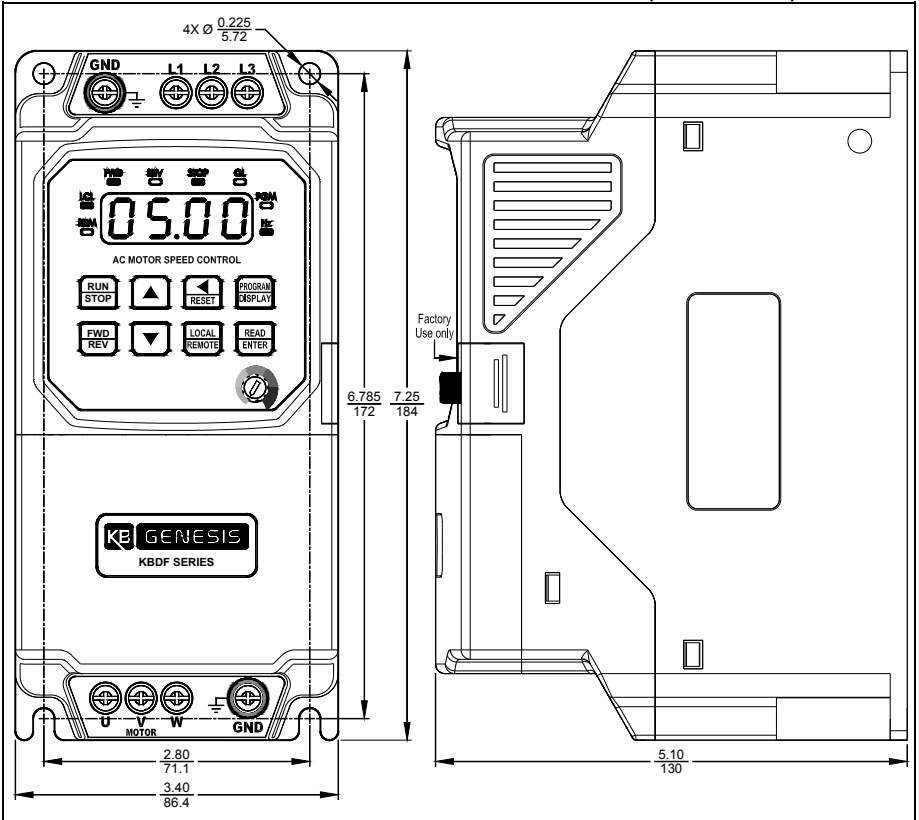
It is recommended that the drive be mounted vertically on a flat surface with adequate ventilation. Leave enough room above and below the drive to allow for AC Line, motor connections, and any other connections that are required. Care should be taken to avoid extreme hazardous locations where physical damage can occur. When mounting the drive in an enclosure, the enclosure should be large enough to allow proper heat dissipation so that the ambient temperature does not exceed 40 °C (104 °F) at full rating. See Figure 4, below, and Figure 5, on page 19.



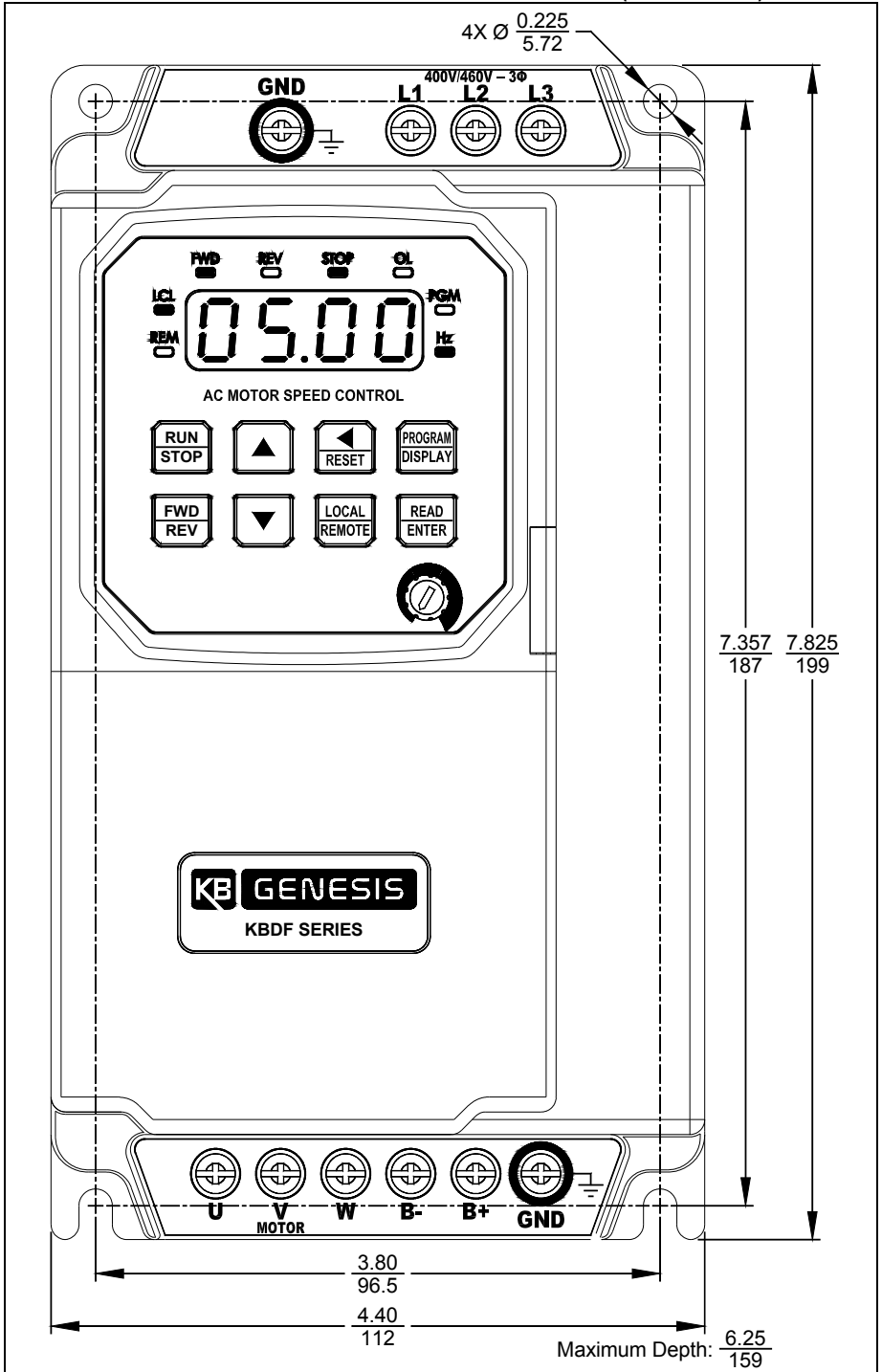
**WARNING! DO NOT USE THIS DRIVE IN AN EXPLOSIVE ENVIRONMENT. AN EXPLOSION CAN CAUSE SERIOUS OR FATAL INJURY. THIS DRIVE IS NOT EXPLOSION PROOF.**

**FIGURE 4**

**CASE "A" DRIVES MECHANICAL SPECIFICATIONS (INCHES / mm)**



**FIGURE 5**  
**CASE "B" DRIVES MECHANICAL SPECIFICATIONS (INCHES / mm)**



---

## 8 ELECTRICAL CONNECTIONS

---

The drive is designed with contactor-type feed-throughs to facilitate wiring of the AC Line input, Motor, and Ground connections, as shown in Figures 7 – 13, on pages 22 - 24.

The removable cover allows access to the terminal blocks and jumpers for wiring and setting up the drive for Remote Operation in lieu of the Keypad (Local Operation).

**Note:** *Wire the control in accordance with the National Electrical Code requirements and other local codes that may apply to the application.*

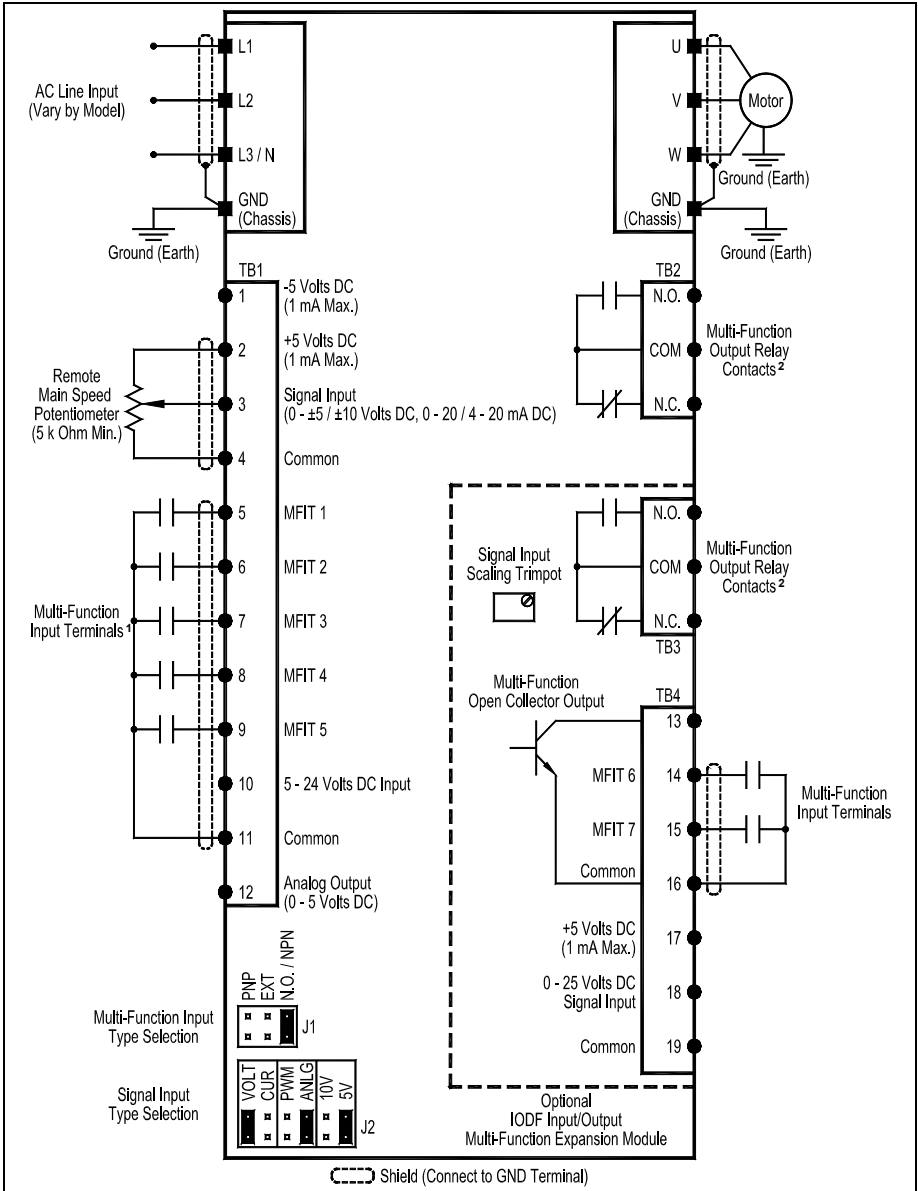


**WARNING! HIGH VOLTAGE! Read Safety Warnings, on page 9, before using the drive. Disconnect the main power before making connections to the drive. To avoid electric shock, be sure to properly ground the drive.**

### Application Notes:

1. To avoid erratic operation, do not bundle AC Line input and motor wires with each other. Also, do not bundle motor wires from multiple drives in the same conduit. Use shielded cables on all signal wiring over 12" (30 cm). The shield should be earth grounded on the drive side only.
2. Be sure to properly fuse each AC Line conductor that is not at ground potential. Do not fuse neutral or grounded conductors. A separate AC Line switch or contactor must be used as a disconnect so that each ungrounded conductor is opened. For fuse or circuit breaker selection, see Table 3, on page 15. Also see Section 8.2, on page 24.
3. If operation with a Ground-Fault Circuit-Interrupter (GFCI) is required, see Function 0.04, on page 55.

**FIGURE 6  
GENERAL CONNECTION DIAGRAM**



**Notes:** 1. Multi-Function Input Terminals (MFIT 1 – 5 on TB1 of the drive) are factory set for N.O. Contacts or NPN Transistors (J1 set to the "N.O. / NPN" position), which use the internal power supply. For NPN Transistors, which use an external power supply (5 – 24 Volts DC), set Jumper J1 to the "EXT" position. For PNP Transistor circuits, which use the internal power supply or an external power supply (5 – 24 Volts DC), set Jumper J1 to the "PNP" position. 2. Multi-Function Output Relay Contact Ratings: 1 Amp at 30 Volts DC, 0.5 Amp at 125 Volts AC, and 0.25 Amp at 250 Volts AC. 3. Multi-Function Input Terminals (MFIT 6 – 7 on TB1 of the IODF) only accept N.O. Contacts or NPN Transistors (which use the internal power supply).

**TABLE 5**  
**DRIVE TERMINAL BLOCK WIRE AND TIGHTENING TORQUE SPECIFICATIONS**

Description	Location	Model <sup>(1)</sup>	Maximum Wire Size (Cu)		Recommended Tightening Torque	
			AWG	mm <sup>2</sup>	Lbs-in	kg-cm
Multi-Function Input Terminals and Signals In/Out	TB1 on Drive and IODF <sup>(2)</sup> (Under Cover)	All	16	1.31	2.7	3.1
Multi-Function Output Relay	TB2 on Drive and TB3 on IODF <sup>(2)</sup> (Under Cover)	All	16	1.31	2.6	2.9
AC Line Input and Ground	Top of Drive	Case "A"	14	2.08	7	8.1
AC Line Input and Ground	Top of Drive	Case "B"	12	3.31	12	14
Motor and Ground	Bottom of Drive	Case "A"	14	2.08	7	8.1
Motor, Ground, and Dynamic Brake Module <sup>(3)</sup>	Bottom of Drive	Case "B"	12	3.31	12	14

**Notes:** 1. Case "A" Drives: Models KBDF-13, 23, 23F, 23D, 23P, 14, 24, 24F, 24D, 24P, 16, 27, 27F, 27D, 27P. Case "B" Drives: Models KBDF-29, 42, 43, 45, 48. 2. The IODF is an optional accessory for all models. 3. The Dynamic Brake Module is an externally mounted optional accessory for Case "B" drives only.

### 8.1 AC LINE INPUT AND GROUND

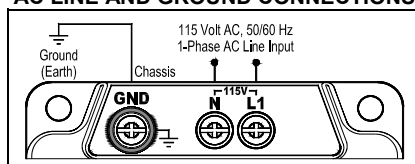
Connect the AC Line input and ground (earth) to the drive as shown in Figures 7 – 13, on pages 22 – 24. Connect the Ground (earth) to the drive chassis Terminal "GND".

**Note:** The rated AC Line voltage of the drive must match the actual AC Line input voltage. See Electrical Ratings, Table 3, on page 15.

**Models KBDF-13, 14, 16:** Designed for 115 Volt 1-phase AC Line input. Connect the AC Line input hot lead to Terminal "L1" and the neutral lead to Terminal "N". See Figure 7.

**Note:** 230 Volts AC will be applied to the motor with 115 Volt AC Line input.

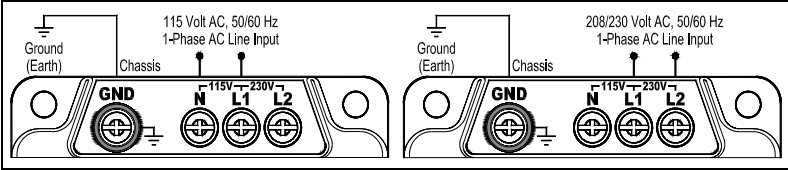
**FIGURE 7**  
**MODELS KBDF-13, 14, 16**  
**AC LINE AND GROUND CONNECTIONS**



**Models KBDF-23D, 24D, 27D:** Designed for 115 and 208/230 Volt 1-phase AC Line input. For 115 Volt Line input, connect the AC Line input hot lead to Terminal "L1" and the neutral lead to Terminal "N". For 208/230 Volt AC Line input, connect to Terminals "L1" and "L2". See Figure 8.

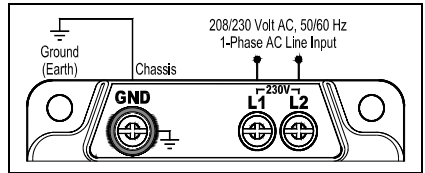
*Note: 230 Volts AC will be applied to the motor with 115 Volt AC Line input.*

**FIGURE 8**  
**MODELS KBDF-23D, 24D, 27D**  
**AC LINE AND GROUND CONNECTIONS**



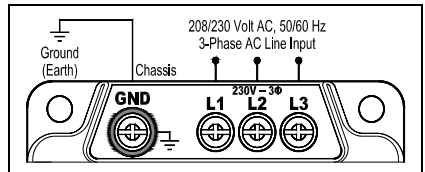
**Models KBDF-23, 23F, 24, 24F, 27, 27F:** Designed for 208/230 Volt 1-phase AC Line input. Connect the AC Line input to Terminals "L1" and "L2". See Figure 9.

**FIGURE 9**  
**MODELS KBDF-23, 23F, 24, 24F, 27, 27F**  
**AC LINE AND GROUND CONNECTIONS**



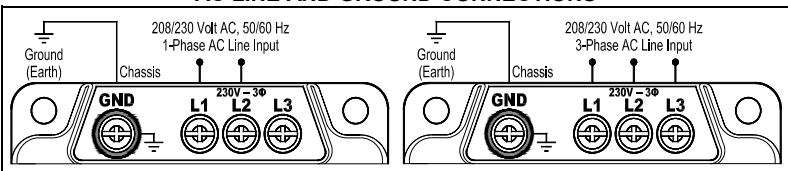
**Models KBDF-23P, 24P:** Designed for 208/230 Volt 3-phase AC Line input. Connect the AC Line input to Terminals "L1", "L2", and "L3". See Figure 10.

**FIGURE 10**  
**MODELS KBDF-23P, 24P**  
**AC LINE AND GROUND CONNECTIONS**



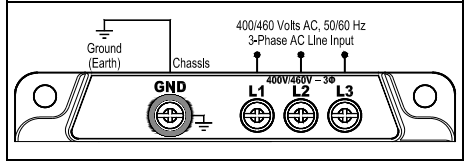
**Models KBDF-27P, 29:** Designed for 208/230 Volt 1-Phase and 3-Phase AC Line Input. Connect the 1-Phase AC Line Input to Terminals "L1" and "L2". Connect the 3-Phase AC Line input to Terminals "L1", "L2", and "L3". See Figure 11.

**FIGURE 11**  
**MODELS KBDF-27P, 29**  
**AC LINE AND GROUND CONNECTIONS**



**Models KBDF-42, 43, 45, 48:** Designed for 400/460 Volt 3-Phase AC Line Input. Connect the AC Line Input to Terminals "L1", "L2", and "L3". See Figure 12.

**FIGURE 12**  
**MODELS KBDF-42, 43, 45, 48**  
**AC LINE AND GROUND CONNECTIONS**



## 8.2 AC LINE INPUT FUSING

The drive does not contain AC Line fuses. For the recommended fuse or circuit breaker rating, see Table 3, on page 15. Do not fuse motor leads.

Most electrical codes require that each ungrounded conductor contain circuit protection. Do not fuse neutral or ground connections.

It is recommended to install a fuse (Littelfuse 326, Buss ABC, or equivalent) or a circuit breaker (Square D QOU or equivalent) in series with each ungrounded conductor.

## 8.3 MOTOR AND GROUND

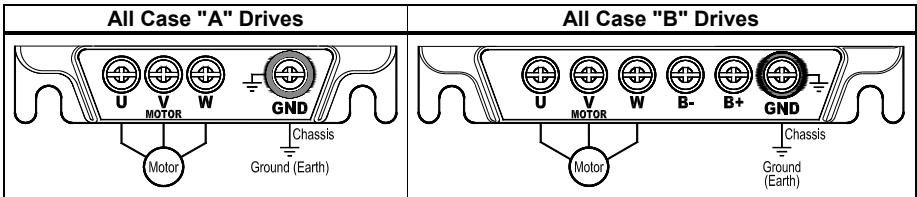
Connect the Motor to Terminals "U", "V", and "W". Connect the Ground (earth) to Terminal "GND". See Figure 13.

Motor cable length should not exceed 100 feet (30 m) – special reactors may be required – consult our Sales Department.

Be sure that the Motor Current (Function 0.01) is programmed to the actual motor nameplate current rating. Do not exceed the drive's maximum current rating.

**Note:** If the motor does not rotate in the desired direction, either: 1. Reverse any two motor leads (with the AC Line disconnected and the motor stopped). 2. Use the FWD/REV Key. 3. Use Function 1.02 to reprogram forward and reverse direction.

**FIGURE 13**  
**MOTOR AND GROUND CONNECTIONS**





## 8.4 REMOTE OPERATION

The Drive is designed with a removable cover to access the Multi-Function Inputs and Outputs and jumpers to set up the drive for remote operation. It also allows access to install the optional accessories. See Table 6.

To remove the cover, press on the finger grips on both side corners of the cover until the retaining clips disengage from the base and lift it up.

After mounting the drive, setting the jumpers, and all connections are complete, replace the cover by inserting the tab into the slot on the drive and gently pressing down on the cover until it snaps into place.

**IMPORTANT:** For remote operation of the drive, both a Start Command and a Frequency Command must be given.

### Application Notes:

1. For additional programmable Multi-Function Inputs and Output install the Optional IODF Input/Output Multi-Function Expansion Module (Part No. 9646). The IODF mounts onto the drive under the front cover. See Appendix A, on page 64.





2. DIF For direct communication between the drive and Modbus RTU protocol, install the optimal DIF RS-232 and RS-485 Modbus RTU Communication Module (Part No. 9647). See Appendix B, on page 67.

**TABLE 6**  
**DRIVE MULTI-FUNCTION INPUT TERMINAL, FUNCTION,**  
**AND FACTORY CODE ASSIGNMENT**

Location	Drive					IODF	
Multi-Function Input Terminal*	1	2	3	4	5	6	7
Number On Terminal Block	5	6	7	8	9	14	15
Function	7.00	7.01	7.02	7.03	7.04	7.05	7.06
Factory Code Setting	0000	0001	0002	0009	0010	0003	0004
Code Description	Preset Frequency Operation	Preset Frequency Operation	Preset Frequency Operation	Reset	N.O. Start	Up Frequency Command	Down Frequency Command

\*Each Multi-Function Input Terminal is controlled by a specific Function. Although factory set to a specific code, they can also be reprogrammed to any code "0000" – "0012" listed in Table 7, on page 26. Also see Function Group 7, on page 60.

**TABLE 7**  
**DRIVE INPUT AND OUTPUT CONNECTIONS<sup>1</sup>**


Terminal Blocks	No.	Description	Specifications	
<p align="center">TB1 on Drive</p> 	1	Power Supply	-5 Volts DC at 1 mA Max.	
	2	Power Supply	+5 Volts DC at 1 mA Max.	
	3	Analog Signal Input	0 – ±5 / ±10 Volts DC, 0 – 20 / 4 – 20 mA DC	
	4	Common <sup>2</sup>	—	
	5	MFIT 1	<u>N.O. Contacts or NPN / PNP Transistors</u> 7 Preset Frequencies, Up Frequency Command, Down Frequency Command, Accel/Decel #2, Forward/Stop Command, Reverse/Stop Command, External Fault (N.O. Contact), Reset, N.O. Start (2-Wire or 3-Wire Start/Stop), N.C. Stop (3-Wire Start/Stop), External Fault (N.C. Contact)	
	6	MFIT 2		
	7	MFIT 3		
	8	MFIT 4		
	9	MFIT 5		
	10	External Power Supply Input	5 – 24 Volts DC Input	
	11	Common <sup>2</sup>	—	
	12	Analog Output	0 – 5 Volts DC	
<p align="center">TB1 on IODF</p> 	13	Open Collector Output	NPN	
	14	MFIT 6	Same As MFIT 1 – MFIT 5 Above	
	15	MFIT 7		
	16	Common <sup>3</sup>	—	
	17	Power Supply	+5 Volts DC at 1 mA Max.	
	18	Analog Input #2	0 – 2.5 thru 0 – 25 Volts DC	
	19	Common <sup>3</sup>	—	
<p align="center">TB2 on Drive</p> 	<p align="center">TB3 on IODF</p> 	N.O.	Normally Open	Run, Fault, Target Frequency (5.03 ± 5.04), Frequency Threshold Level (> 5.03 – 5.04), Frequency Threshold Level (< 5.03 + 5.04), I <sup>2</sup> t or I <sup>2</sup> t Fault, Load Loss (See 5.05), External Fault
		COM	Relay Common <sup>4</sup>	
		N.C.	Normally Closed	

**Notes:** 1. For additional inputs and outputs, install the optional IODF Input/output Multi-Function Expansion Module (Part No. 9646). See Appendix A, on page 64. 2. Common Terminals "4", "11", "16", and "19" are internally wired together. 4. Relay Commons are not internally wired to Common Terminals "4", "11", "16", and "19".

### 8.4.1 START/STOP AND FORWARD/REVERSE

The drive can be started and stopped using 2-Wire or 3-Wire Start/Stop Contacts connected to the Multi-Function Input Terminals. Also, some applications may require a jumper, which will provide automatic starting of the drive when either a forward or reverse contact is closed. See Figure 14, below, for the connections and drive programming.

**Application Note:** A frequency command must also be given for the drive to run.

 **WARNING! STOP is not to be used as an Emergency Stop or safety disconnect since it is not fail-safe. Use only the AC line for this purpose.**

#### **APPLICATION NOTES FOR AUTO/MANUAL START MODE (FUNCTION 1.05)**


1.If the drive is set for Manual Start Mode ("0000" (factory setting)), Manual Start with Ride-Through ("0001"), or Auto Start After Undervoltage Fault Clears ("0002"), it will have to be manually restarted after the external fault has been cleared. Use the Reset Key on the Keypad or the external Reset Contact to restart the drive.

2.If the drive is set for Auto Start All Faults (Except Short circuit Fault) ("0003"), it will automatically restart after the external fault has been cleared, for the number of restart attempts set in Function 1.07 (factory set to 3). After which, the drive will have to be restarted using the Reset Key on the Keypad or the external Reset Contact.

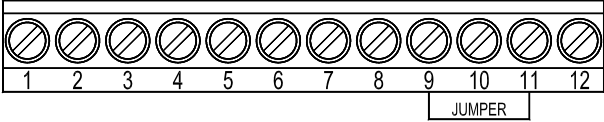
3.If the drive is set for Auto Start All Faults (Except I<sup>2</sup>t, I•t, and Short Circuit Faults) ("0003"), it will automatically restart after the external fault has been cleared.

#### 8.4.1.1 AUTOMATIC START

Some applications will require that the drive automatically start when the AC Line is applied. See Figure 14, for connections and drive programming.

 **WARNING! Using a jumper to automatically start or restart the drive will cause the motor to run at the Set Frequency of the drive when the AC Line is applied.**

**FIGURE 14  
AUTOMATIC START  
CONNECTIONS AND DRIVE PROGRAMMING**

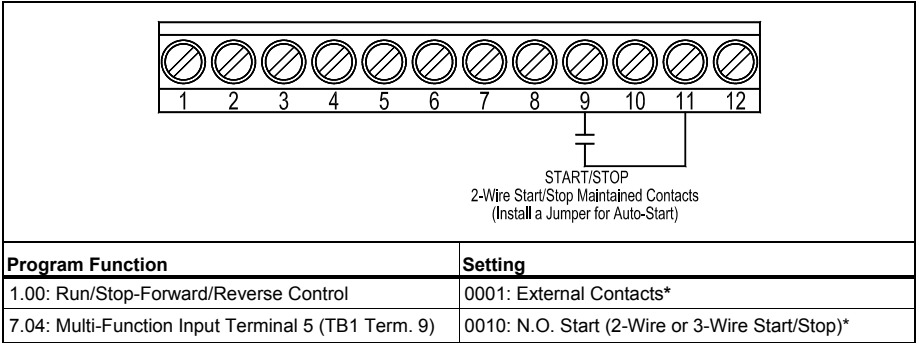
	
Program Function	Setting
1.00: Run/Stop-Forward/Reverse Control	0001: External Contacts*
1.05: Auto/Manual Start Mode (Choose a code ( 0002, 0003, or 0004) as required by the application.)	0002: Auto Start After Undervoltage Fault Clears
	0003: Auto Start All Faults (Except I <sup>2</sup> t, I•t, and Short Circuit Faults)
	0004: Auto Start All Faults (Except Short Circuit Fault)
7.04: Multi-Function Input Terminal 5 (TB1 Term. 9)	0010: N.O. Start (2-Wire or 3-Wire Start/Stop)*

\*Factory setting.

### 8.4.1.2 2-WIRE START/STOP

Close the Start/Stop Contact to Start the drive. Open the Start/Stop Contact to the Stop the drive. See Figure 15, for connections and drive programming.

**FIGURE 15**  
**2-WIRE START/STOP**  
**CONNECTIONS AND DRIVE PROGRAMMING**

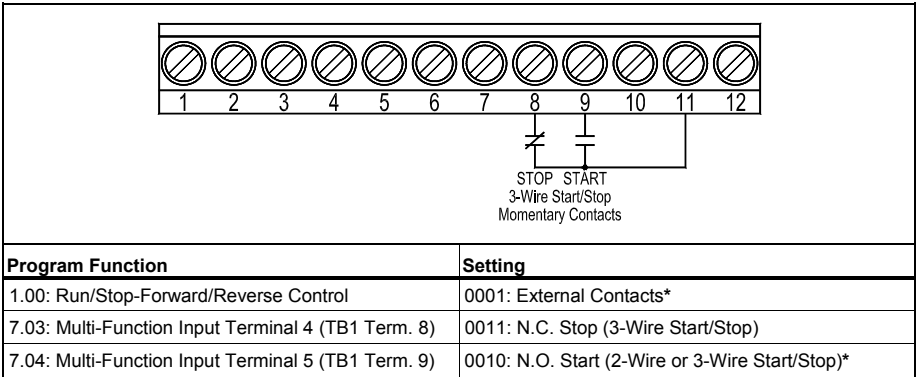


\*Factory setting.

### 8.4.1.3 3-WIRE START/STOP

Momentarily close the Start/Stop Contact to Start the drive. Momentarily open the Start/Stop Contact to Stop the drive. See Figure 16, for connections and drive programming.

**FIGURE 16**  
**3-WIRE START/STOP**  
**CONNECTIONS AND DRIVE PROGRAMMING**



\*Factory setting.

### 8.4.1.4 FORWARD/STOP AND REVERSE/STOP

Remote Forward/Stop and Reverse/Stop operation can be performed by connecting contacts to the Multi-Function Input Terminals. Close the Forward Contact to run the drive in the forward direction. Close the Reverse Contact to run the drive in the reverse direction. Open the contact to stop the drive. See Figure 17, for connections and drive programming.

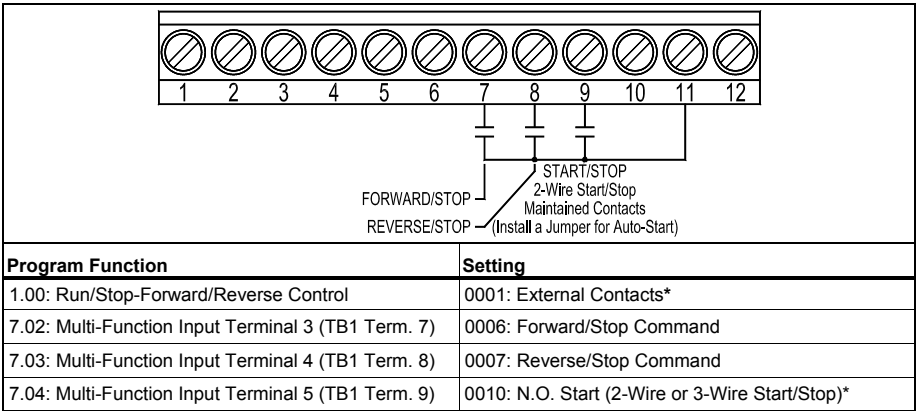
Connect the Start/Stop Contact to Terminal "9", which is factory set for N.O. Start ("0010"). Connect the Forward/Stop and Reverse/Stop Contacts to any Multi-Function Input (TB1 Terminals "1" – "5"). Terminals "7" and "8" have been arbitrarily chosen for Forward/Stop and Reverse Stop. The common of the contacts can be connected to either common Terminal "4" or "11".

#### Application Note:

The drive will operate in the forward direction without assigning a Multi-Function Input Terminal code "0006" (Forward/Stop Command) or "0007" (Reverse/Stop Command). Once these codes are assigned to a Multi-Function Input Terminal, a contact must be used to select forward or reverse direction.

**Operation:** When the Forward/Stop Contact is closed, the drive will run in the forward direction. When the Forward/Stop Contact is opened, the drive will stop. When the Reverse/Stop Contact is closed, the drive will run in the reverse direction. When the Reverse/Stop Contact is opened, the drive will stop.

**FIGURE 17  
FORWARD/STOP AND REVERSE/STOP  
CONNECTIONS AND DRIVE PROGRAMMING**



\*Factory setting.

## 8.4.2 FREQUENCY CONTROL

The drive's output frequency can be controlled by various methods:

1. Analog Input (Voltage following, Current Following). See Section 8.4.2.1, below.
2. Remote Main Speed Potentiometer. See Section 8.4.2.2, on page 32.
3. Up/Down Frequency Control (using the Multi-Function Input Terminals). See Section 8.4.2.3, on page 34.
4. Preset Frequency (using the Multi-Function Input Terminals). See Section 8.4.2.4, on page 37.
5. Modbus Communication using the optional DIFD RS-232 and RS-485 Modbus RTU Communication Module. See Appendix B, on page 67.

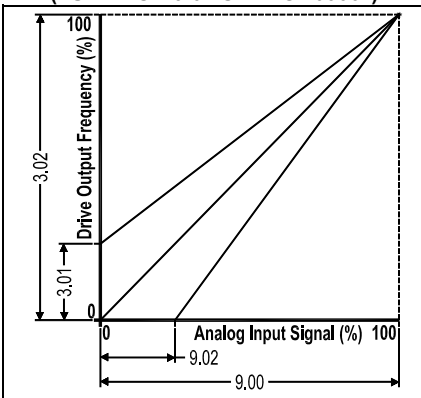
### 8.4.2.1 ANALOG INPUT

An analog voltage (unidirectional or bidirectional), current, or PWM signal input can be used to control motor speed in lieu of the Keypad. The drive output will linearly follow the signal input. The inputs can be programmed for the desired gain, slope, offset, and response time.

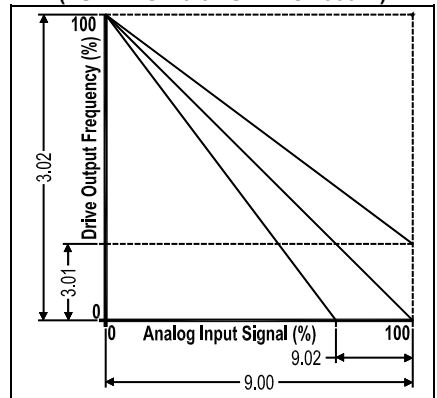
**Operation with a Positive Slope Signal:** When the signal input is increased, the drive output frequency will increase. When the signal input is decreased, the drive output frequency will decrease. See Figure 18.

**Operation with a Negative Slope Signal:** When the signal input is increased, the drive output frequency will decrease. When the signal input is decreased, the drive output frequency will increase. See Figure 19.

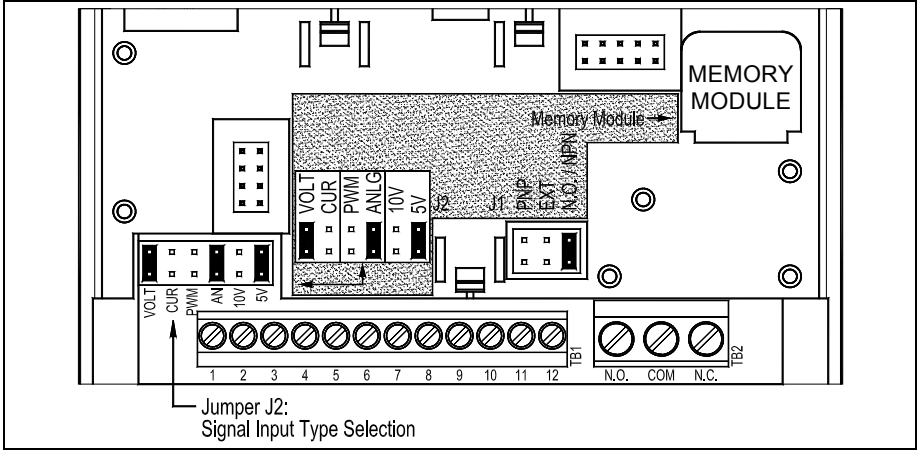
**FIGURE 18**  
ANALOG INPUT SIGNAL GAIN  
AND OFFSET WITH POSITIVE SLOPE  
(LOW-TO-HIGH SIGNAL)  
(FUNCTION 9.01 SET TO "0000")



**FIGURE 19**  
ANALOG INPUT SIGNAL GAIN  
AND OFFSET WITH NEGATIVE SLOPE  
(HIGH-TO-LOW SIGNAL)  
(FUNCTION 9.01 SET TO "0001")



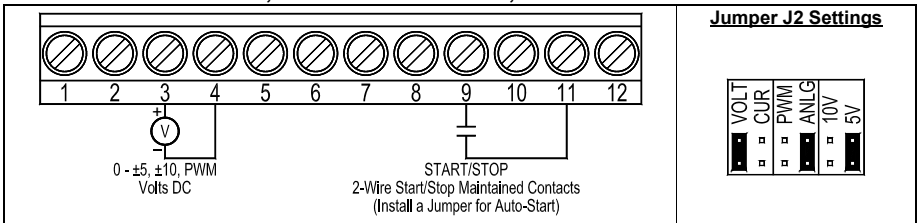
**FIGURE 20**  
**ANALOG INPUT JUMPER J2 SETTINGS**



**8.4.2.1.1 VOLTAGE FOLLOWING**

Connect the 0 – ±5 or 0 – ±10 Volt DC Voltage Signal input to TB1 Terminal "3" and the common to TB1 Terminal "4". Set Jumper J2 to the corresponding signal input voltage (factory set to "5V" position). Connect the Start (Jumper) to TB1 Terminal "9", which is factory set to N.O. Start ("0010") and to either common TB1 Terminal "4" or "11" Set the signal Slope and Type and adjust the Gain, Offset, and Response Time as desired. See Figure 21, for connections, Jumper J2 settings, and drive programming.

**FIGURE 21**  
**VOLTAGE FOLLOWING**  
**CONNECTIONS, JUMPER J2 SETTINGS, AND DRIVE PROGRAMMING**



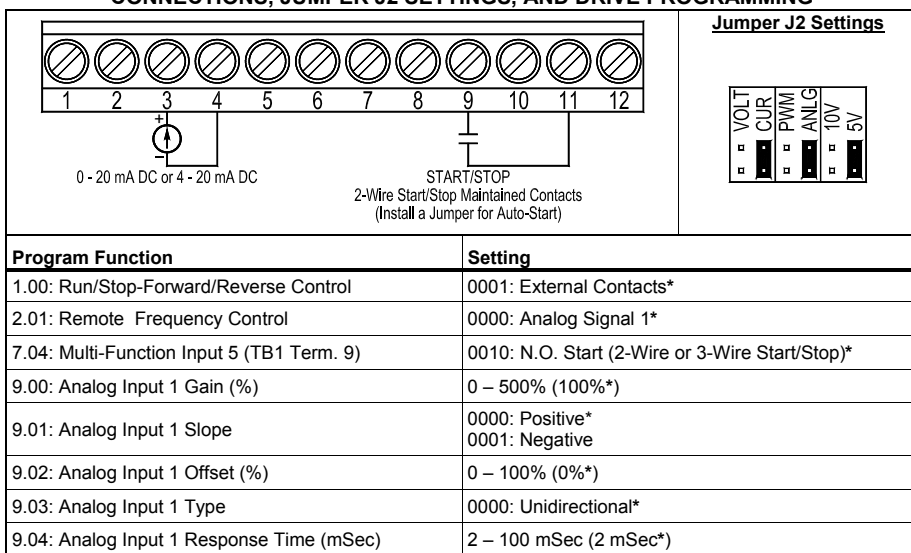
Program Function	Setting
1.00: Run/Stop-Forward/Reverse Control	0001: External Contacts*
2.01: Remote Frequency Control	0000: Analog Signal 1*
7.04: Multi-Function Input 5 (TB1 Term. 9)	0010: N.O. Start (2-Wire or 3-Wire Start/Stop)*
9.00: Analog Input 1 Gain (%)	0 – 500% (100%*)
9.01: Analog Input 1 Slope	0000: Positive* 0001: Negative
9.02: Analog Input 1 Offset (%)	0 – 100% (0%*)
9.03: Analog Input 1 Type	0000: Unidirectional* 0001: Bidirectional 0002: PWM
9.04: Analog Input 1 Response Time (mSec)	2 – 100 mSec (2 mSec*)

\*Factory setting.

### 8.4.2.1.2 CURRENT FOLLOWING

Connect the 0 – 20 mA or 4 – 20 mA DC Current Signal input to TB1 Terminal "3" and the common to TB1 Terminal "4". Set Jumper J2 to "CUR" and be sure it is also set to "ANLG" and "5V". Connect the Start (Jumper) to TB1 Terminal "9", which is factory set for N.O. Start ("0010") and to either common TB1 Terminal "4" or "11" Set the signal Slope and Type and adjust the Gain, Offset, and Response Time as desired. See Figure 22, for connections, Jumper J2 settings, and drive programming.

**FIGURE 22**  
**CURRENT FOLLOWING**  
**CONNECTIONS, JUMPER J2 SETTINGS, AND DRIVE PROGRAMMING**



\*Factory setting.

### 8.4.2.2 REMOTE MAIN SPEED POTENTIOMETER

A remote Main Speed Potentiometer (5 kΩ) can be used in lieu of the Keypad or the Built-In Potentiometer on the drive to control motor speed. The potentiometer can be connected for Unidirectional Operation, Bidirectional Operation with center off, or Bidirectional Operation with Forward/Reverse Contacts.

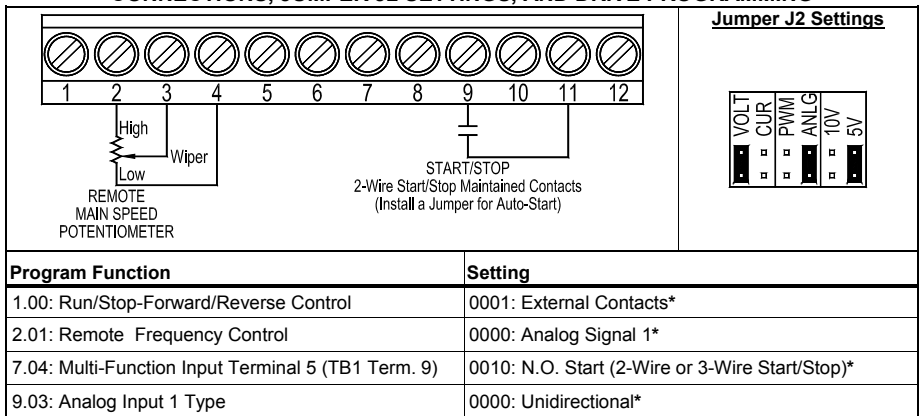
#### Unidirectional Operation with 2-Wire Start/Stop

Connect the high side of the Main Speed Potentiometer to TB1 Terminal "2" (+5 Volts), the wiper to TB1 Terminal "3" (Analog Signal Input), and low side to either TB1 Terminal "4" or "11" (Common). Connect the Start/Stop Contact to TB1 Terminal "9", which is factory set for N.O. Start ("0010") and to either TB1 Terminal "4" or "11". See Figure 23, on page 33, for connections, Jumper J2 settings, and drive programming.

**Operation:** Close the Start/Stop Contact to start the drive. Rotate the Main Speed Potentiometer clockwise to increase motor speed. Rotate the Main speed Potentiometer counterclockwise to decrease motor speed. Open the Start/Stop Contact to stop the drive.



**FIGURE 23**  
**UNIDIRECTIONAL REMOTE MAIN SPEED POTENTIOMETER WITH START/STOP CONNECTIONS, JUMPER J2 SETTINGS, AND DRIVE PROGRAMMING**



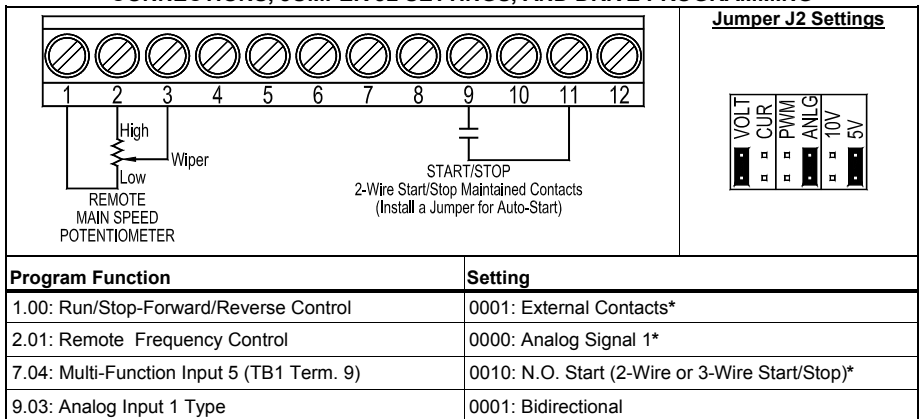
\*Factory setting.

**Bidirectional Operation with 2-Wire Start/Stop**

Connect the high side of the Main Speed Potentiometer to TB1 Terminals "2" (+5 Volts), the wiper to TB1 Terminal "3" (Analog Signal Input), and the low side to TB1 Terminal "1" (-5 Volts). Connect the Start/Stop Contact to TB1 Terminal "9", which is factory set for N.O. Start ("0010"), and to either TB1 Terminal "4" or "11". See Figure 24, for connections, Jumper J2 settings, and drive programming.

**Operation:** Close the Start/Stop contact to start the drive. At 50% rotation, the Main Speed Potentiometer is set for zero speed. Rotating the Main Speed Potentiometer clockwise will increase motor frequency in the forward direction. Rotating the Main Speed Potentiometer counterclockwise will increase motor frequency in the reverse direction. Open the Start/Stop Contact to stop the drive.

**FIGURE 24**  
**BIDIRECTIONAL REMOTE MAIN SPEED POTENTIOMETER WITH START/STOP CONNECTIONS, JUMPER J2 SETTINGS, AND DRIVE PROGRAMMING**



\*Factory setting.

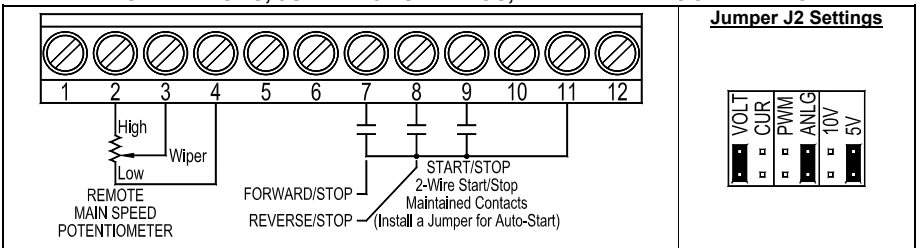
### **Bidirectional Operation with Forward/Reverse**

Connect the high side of the Main Speed Potentiometer to TB1 Terminals "2" (+5 Volts), the wiper to TB1 Terminal "3" (Analog Signal Input), and the low side to TB1 Terminal "1" (-5 Volts). Connect the Start/Stop Contact to TB1 Terminal "9", which is factory set for N.O. Start ("0010"), and to either TB1 Terminal "4" or "11". Connect the Forward/Stop Contact to TB1 Terminal "7" and to either common TB1 Terminal "4" or "11". Connect the Reverse/Stop Contact to TB1 Terminal "8" and either common TB1 Terminal "4" or "11". See Figure 25, for connections, Jumper J2 settings, and drive programming.

**Operation:** Close the Forward/Stop or Reverse/Stop Contact to put the drive in the Forward Run Mode or Reverse Run Mode. Rotate the Main Speed Potentiometer clockwise to increase motor speed and rotate the Main Speed Potentiometer counterclockwise to decrease motor speed. Open the contact to put the drive in the Stop Mode.

**FIGURE 25**

### **BIDIRECTIONAL REMOTE MAIN SPEED POTENTIOMETER WITH FORWARD/REVERSE CONNECTIONS, JUMPER J2 SETTINGS, AND DRIVE PROGRAMMING**



Program Function	Setting
1.00: Run/Stop-Forward/Reverse Control	0001: External Contacts*
2.01: Remote Frequency Control	0000: Analog Signal 1*
7.02: Multi-Function Input Terminal 3 (TB1 Term. 7)	0006: Forward/Stop Command
7.03: Multi-Function Input Terminal 4 (TB1 Term. 8)	0007: Reverse/Stop Command
7.04: Multi-Function Input Terminal 5 (TB1 Term. 9)	0010: N.O. Start (2-Wire or 3-Wire Start/Stop)*
9.03: Analog Input 1 Type	0001: Bidirectional

\*Factory setting.

### **8.4.2.3 UP/DOWN FREQUENCY CONTROL**

Up/Down Frequency Control allows the drive output frequency to be increased and decreased with a remote "Up" contact and "Down" contact. The "Up" contact increases drive output frequency and the "Down" contact decreases the drive output frequency. See Figure 26, on page 35, for connections and drive programming.

**Free-Running Operation:** When the Up Contact is closed, the drive output frequency will increase for the duration of the contact closure. When the Up Contact is opened, the drive output frequency will stop increasing. When the Down Contact is closed, the drive output frequency will decrease for the duration of the contact closure. When the Down Contact is opened, the drive output frequency will stop decreasing.

**Incremental Operation:** For each activation of the Up Contact, the drive output frequency will increase incrementally, equal to the frequency set by Function 7.15 (factory set to 1.00 Hz). For

each activation of the Down Contact, the drive output frequency will decrease incrementally, equal to the frequency set by Function 7.15 (factory set to 1.00 Hz).

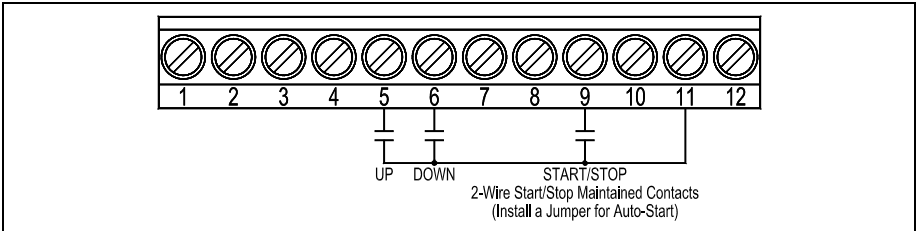
**Note:** In Incremental Operation, if the Up or Down Contact is maintained for longer than 2 seconds, the drive output frequency will "free run" up or down in increments set by Function 7.15, for the duration of the contact closure. The rate of change is equal to the Accel/Decel settings in Function Nos. 3.03 and 3.04. When the contact is opened, the drive output frequency will stop changing.

**Unidirectional Up/Down Frequency Control**

Connect the Start/Stop Contact to TB1 Terminal "9", which is factory set for N.O. Start ("0010"). The common of the contacts can be connected to either common TB1 Terminal "4" or "11".

**Note:** Use a maintained contact for Start/Stop. If a Start/Stop Contact is not used, a jumper must be installed between TB1 Terminals "5" and "8".

**FIGURE 26  
UNIDIRECTIONAL UP/DOWN FREQUENCY CONTROL WITH 2-WIRE START/STOP CONNECTIONS AND DRIVE PROGRAMMING**



Program Function	Setting
1.00: Run/Stop-Forward/Reverse Control	0001: External Contacts*
2.01: Remote Frequency Control	0003: Up/Down Using MFITs
7.00: Multi-Function Input Terminal 1 (TB1 Term. "5")	0003: Up Frequency Command**
7.01: Multi-Function Input Terminal 2 (TB1 Term. "6")	0004: Down Frequency Command**
7.04: Multi-Function Input Terminal 5 (TB1 Term. "9")	0010: N.O. Start (2-Wire or 3-Wire Start/Stop)*
7.14: Up/Down Frequency Control Mode	0000: Free Running* 0001: Incremental Change
7.15: Increment of Up/Down Frequency (Hz)	0.01 – 30.00 Hz (1.00 Hz*)

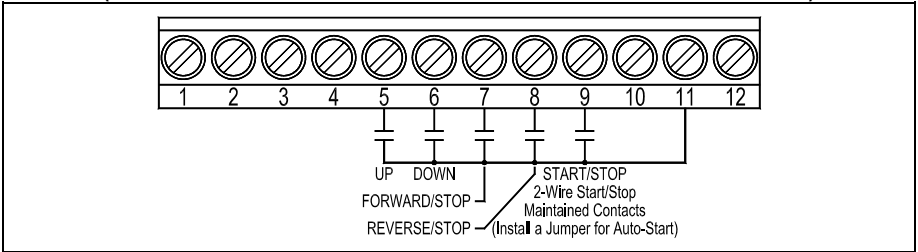
\*Factory setting.

\*\*Use with Function 7.14 code "0001 only.

### **Bidirectional Up/down Frequency Control**

Connect the Start (Jumper) to Multi-Function Input Terminal 9, which is factory set for N.O. Start ("0010"). Connect the Forward/Stop and Reverse/Stop Contacts to any Multi-Function Input Terminals "1" – "7". TB1 Terminals "3" and "4" have been arbitrarily chosen for Forward/Stop and Reverse Stop. The common of the contacts can be connected to either common TB1 Terminal "4" or "11". See Figure 27, for connections and drive programming.

**FIGURE 27**  
**BIDIRECTIONAL UP/DOWN FREQUENCY CONTROL**  
**CONNECTIONS AND DRIVE PROGRAMMING**  
**(WITH FORWARD/STOP – REVERSE/STOP AND 2-WIRE START/STOP)**



<b>Program Function</b>	<b>Setting</b>
1.00: Run/Stop-Forward/Reverse Control	0001: External Contacts*
2.01: Remote Frequency Control	0003: Up/Down Using MFITs
7.00: Multi-Function Input Terminal 1 (TB1 Term. "5")	0003: Up Frequency Command**
7.01: Multi-Function Input Terminal 2 (TB1 Term. "6")	0004: Down Frequency Command**
7.02: Multi-Function Input Terminal 3 (TB1 Term. "7")	0006: Forward/Stop Command
7.03: Multi-Function Input Terminal 4 (TB1 Term. "8")	0007: Reverse/Stop Command
7.04: Multi-Function Input Terminal 5 (TB1 Term. "9")	0010: N.O. Start (2-Wire Start/Stop)*
7.14: Up/Down Frequency Control Mode	0000: Free Running* 0001: Incremental Change
7.15: Increment of Up/Down Frequency (Hz)	0.01 – 30.00 Hz (1.00 Hz*)

\*Factory setting.

\*\*Use with Function 7.14 code "0001" only.

#### 8.4.2.4 PRESET FREQUENCY CONTROL

The drive is factory programmed for 7 Preset Frequencies, which can be selected using remote contacts connected to Multi-Function Input Terminals "1", "2", and "3" (TB1 Terminals "5", "6", and "7"). See Table 8, for the terminals to select for the preset frequencies.

The 7 Preset Frequencies are obtained using a combination of Multi-Function Input Terminals 1, 2, 1+2, 3, 1+3, 2+3, 1+2+3. The Preset Frequencies can be changed from their factory settings by reprogramming Function 7.07 – 7.13.

**8th Preset Frequency:** If none of the Multi-Function Input Terminals are activated, the drive will operate at the Stored Set Frequency (Function No. 3.00) of 5.00 Hz. If the 8th Preset Frequency is not required, set Function No. 3.00 to 00.00 Hz.

**Note:** For Preset Frequency Operation, the drive does not have to be reprogrammed for External Contact Operation. Multi-Function Input Terminals "1", "2", and "3" (TB1 Terminals "5", "6", and "7") are factory set to codes "0000", "0001", and "0002".

**TABLE 8  
PRESET FREQUENCY SELECTION**

Multi-Function Input Terminals to Select			Preset Frequency		
TB1 Terminal "5"	TB1 Terminal "6"	TB1 Terminal "7"	No.	Function No.	Hz (Factory Setting)
Function No. 7.00 Set to "0000"*	Function No. 7.01 Set to "0001"*	Function No. 7.02 Set to "0002"*			
•			1	7.07	10.00
	•		2	7.08	15.00
•	•		3	7.09	20.00
		•	4	7.10	25.00
•		•	5	7.11	30.00
	•	•	6	7.12	35.00
•	•	•	7	7.13	40.00

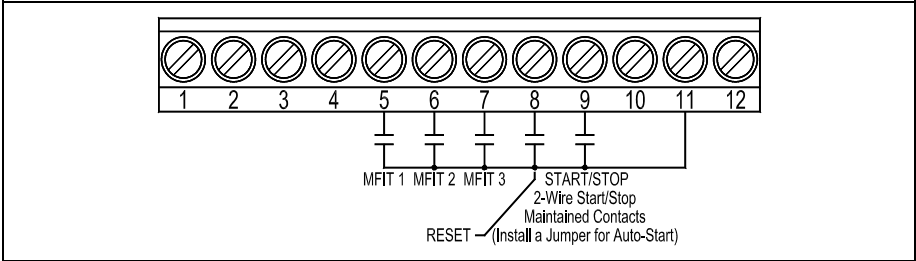
\*Factory setting.

See Figures 28 and 29, on page 38, for connections and drive programming. The common of the contacts can be connected to either common TB1 Terminal "4" or "11".

Connect the Preset Frequency Contacts to Multi-Function Input Terminals "1", "2", and "3" (TB1 Terminals "5", "6", and "7"). Use Functions 7.07 – 7.13 to program the desired Preset Frequencies.

**Application Note:** Closing the Star/Stop Contact, without any of the Multi-Function Input Terminals "1", "2", and "3" (TB1 Terminals "5", "6", and "7") contacts activated, will result in the drive operating at the factory preset frequency of 5.00 Hz. For zero speed operation, reprogram Function 3.00 to "00.00" Hz.

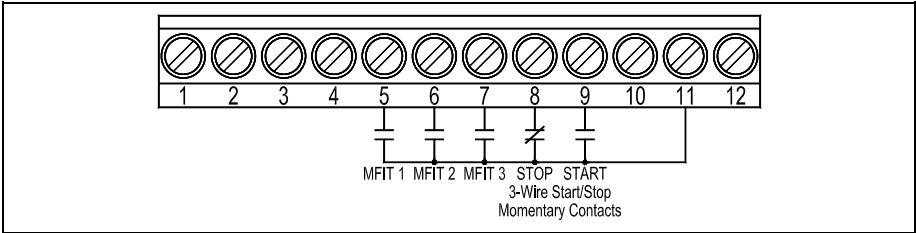
**FIGURE 28**  
**UNIDIRECTIONAL PRESET FREQUENCY SELECTION WITH 2-WIRE START/STOP CONNECTIONS AND DRIVE PROGRAMMING**



Program Function	Setting
1.00: Run/Stop-Forward/Reverse Control	0001: External contacts
3.00: Stored Set Frequency (Hz)	00.00 Hz
7.00: Multi-Function Input Terminal 1 (TB1 Term. 5)	0000: Preset Frequency Operation*
7.01: Multi-Function Input Terminal 2 (TB1 Term. 6)	0001: Preset Frequency Operation*
7.02: Multi-Function Input Terminal 3 (TB1 Term. 7)	0002: Preset Frequency Operation*
7.03: Multi-Function Input Terminal 4 (TB1 Term. 8)	0009: Reset*
7.04: Multi-Function Input Terminal 5 (TB1 Term. 9)	0010: N.O. Start (2-Wire or 3-Wire Start/Stop)*

\*Factory setting.

**FIGURE 29**  
**UNIDIRECTIONAL PRESET FREQUENCY SELECTION WITH 3-WIRE START/STOP CONNECTIONS AND DRIVE PROGRAMMING**



Program Function	Setting
1.00: Run/Stop-Forward/Reverse Control	0001: External contacts*
3.00: Stored Set Frequency (Hz)	00.00 Hz
7.00: Multi-Function Input Terminal 1 (TB1 Term. 5)	0000: Preset Frequency Operation*
7.01: Multi-Function Input Terminal 2 (TB1 Term. 6)	0001: Preset Frequency Operation*
7.02: Multi-Function Input Terminal 3 (TB1 Term. 7)	0002: Preset Frequency Operation*
7.03: Multi-Function Input Terminal 4 (TB1 Term. 8)	0011: N.C. Stop (3-Wire Start/Stop)
7.04: Multi-Function Input Terminal 5 (TB1 Term. 9)	0010: N.O. Start (2-Wire or 3-Wire Start/Stop)*

\*Factory setting.

**8.4.2.5 MODBUS COMMUNICATION**

The optional DIDF RS-232 and RS-485 Modbus RTU Communication Module allows direct communication between the drive and Modbus RTU protocol. See Appendix B, on page 68.

### 8.4.3 MULTI-FUNCTION INPUT TERMINALS

The Multi-Function Input Terminals can be used control the drive for Reset, External Fault, and Accel/Decel #2. For NPN and PNP Circuits, see Appendix E, on page 70.

#### 8.4.3.1 RESET

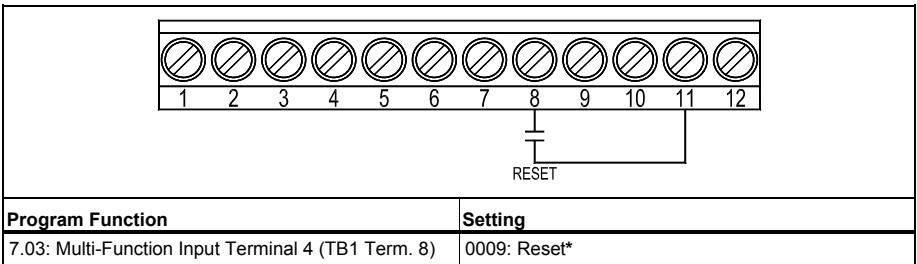
It is advisable to connect a momentary normally open contact to Multi-Function Input Terminal "4". This allows the drive to be restarted after a fault has been cleared. See Figure 30, for connections and drive programming.

**⚠ CAUTION!** If a maintained Reset Contact is used and kept in the closed position while the drive is in the Run Mode (Start jumpered or the Start/Stop contact is in the "Start" position) and a direction is selected, the drive will automatically restart after a fault has been cleared.

Connect the Reset Contact to Multi-Function Input Terminal "4" (TB1 Terminal "8"), which is factory set to Reset ("0009"). The common of the contact can be connected to either common TB1 Terminal "4" or "11".

**Operation:** When a fault has been cleared, momentarily activate the Reset Contact to reset the drive.

**FIGURE 30  
RESET  
CONNECTIONS AND DRIVE PROGRAMMING**



\*Factory setting.

#### 8.4.3.2 EXTERNAL FAULT

The Multi-Function Input Terminals can be used to "stop" the drive when a fault condition occurs elsewhere in the equipment. The connection to the Multi-Function Input Terminal can be from a normally open or normally closed relay contact or PLC. See Figure 31, on page 40, for connections and drive programming.

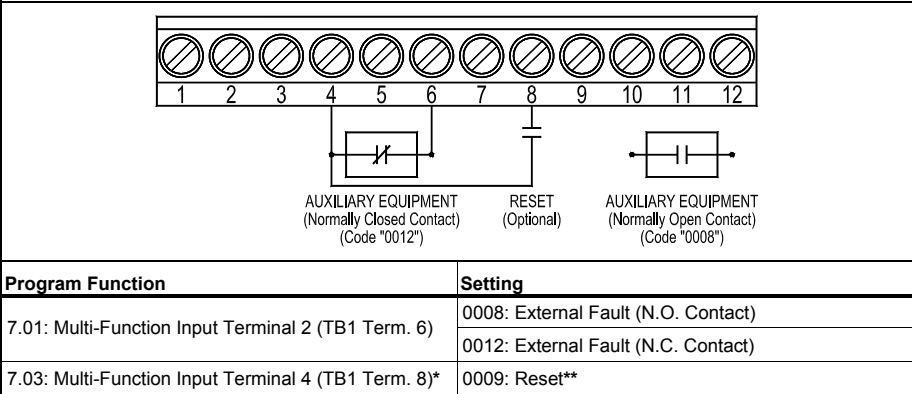
**⚠ WARNING!** External Fault is not to be used as an Emergency Stop or safety disconnect since it is not fail-safe. Use only the AC line for this purpose.

**Note:** For a normally open contact, program the respective Multi-Function Input Terminal to "0008". For a normally closed contact, program the respective Multi-Function Input Terminal to "0012".

Connect the auxiliary equipment contact to any Multi-Function Input Terminal "1" – "7". TB1 Terminal "6" has been arbitrarily chosen for External Fault. The common of the circuit can be connected to either common TB1 Terminal "4" or "11".

**Operation:** When the circuit is activated, the drive will "stop" and the display of the drive will show "EF-t". In order to restart the drive, after the fault has been cleared, either press the Reset Key on the Keypad or use an external contact connected to Multi-Function Input Terminal "4" (TB1 Terminal "8").

**FIGURE 31  
EXTERNAL FAULT  
CONNECTIONS AND DRIVE PROGRAMMING**



\*Factory setting.

\*\*Optional.

**8.4.3.3 ACCEL/DECCEL #2**

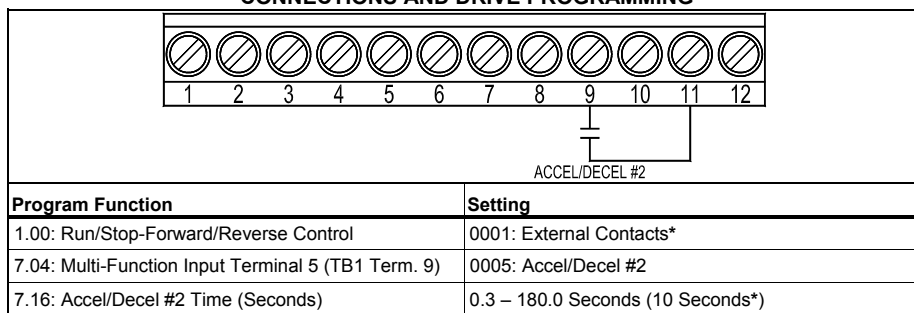
The drive provides a secondary Accel/Decel Time setting, which can be remotely selected with a normally open contact connected to a Multi-Function Input Terminal. See Figure 32, on page 41, for connections and drive programming. Accel/Decel #2 overrides the Accel and Decel settings in Function Nos. 3.03 and 3.04.

Connect the Accel/Decel #2 Contact to any Multi-Function Input Terminal "1" – "5" (TB1 Terminals "5" – "9"). TB1 Terminal "9" has been arbitrarily chosen for Accel/Decel #2. The common of the contact can be connected to either common TB1 Terminal "4" or "11".

**Operation:** When the contact is closed, the Accel/Decel #2 setting is selected. When the contact is opened, the drive reverts to the Accel/Decel settings in Functions 3.03 and 3.04.



**FIGURE 32  
ACCEL/DECEL #2  
CONNECTIONS AND DRIVE PROGRAMMING**



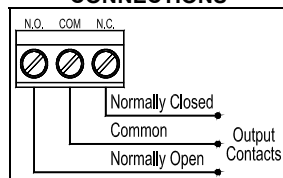
\*Factory setting.

### 8.4.4 MULTI-FUNCTION OUTPUT RELAY

The Multi-Function Output Relay connections are located on TB2, as shown in Figure 33. To access TB2, remove the drive's cover. See Section 8.4, on page 25.

The Multi-Function Output Relay is factory programmed to function as a "Run" Relay (Function 5.00 set to "0000"). When the drive is put into the Run Mode, the relay contacts will change state (the Normally Open (N.O.) contact will close and the Normally Closed (N.C.) contact will open). See Table 9. See Function 5.00, on page 58, for other modes of operation.

**FIGURE 33  
MULTI-FUNCTION  
OUTPUT RELAY  
CONNECTIONS**



For an additional Multi-function Output Relay, install the optional IODF Input/Output Multi-Function Expansion Module (Part No. 9646). See Function 5.01, on page 58.

**TABLE 9  
DRIVE MULTI-FUNCTION OUTPUT RELAY "RUN" AND "FAULT" OPERATING MODES**

Drive Operating Condition	"Run" Relay Mode (Function 5.00 Set to "0000")		"Fault Relay Mode (Function 5.00 Set to "0001")	
	N.O. Contact	N.C. Contact	N.O. Contact	N.C. Contact
Power Off	Open	Closed	Open	Closed
Power On (Stop Mode)	Open	Closed	Closed	Open
Run Mode	Closed	Open	closed	Open
All Faults	Open	Closed	Open	Closed

### Other Programmable Functions of the Multi-Function Output Relay (Function 5.00)

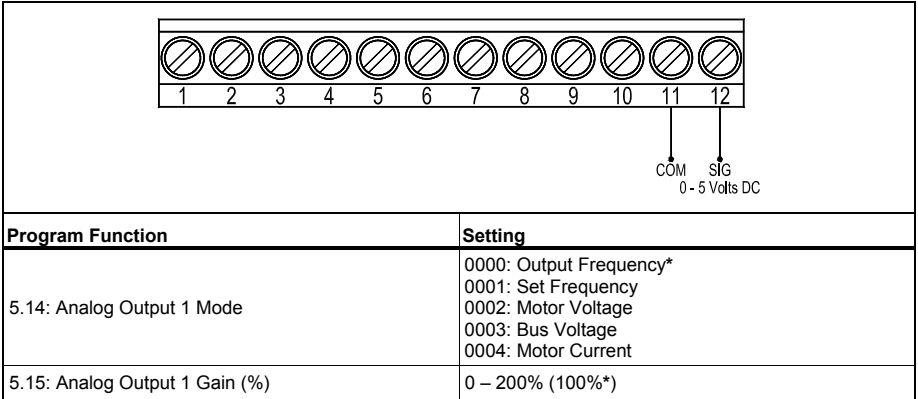
**Code Description**

- 0000:** Run
- 0001:** Fault
- 0002:** Target Frequency (Function 5.03 ± Function 5.04)
- 0003:** Frequency Threshold Level (>Function 5.03 – Function 5.04)
- 0004:** Frequency Threshold Level (<Function 5.03 + Function 5.04)
- 0005:** I<sup>2</sup>t or I-t Fault
- 0006:** Load Loss (See Function 5.05)
- 0007:** External Fault

### 8.4.5 ANALOG OUTPUT

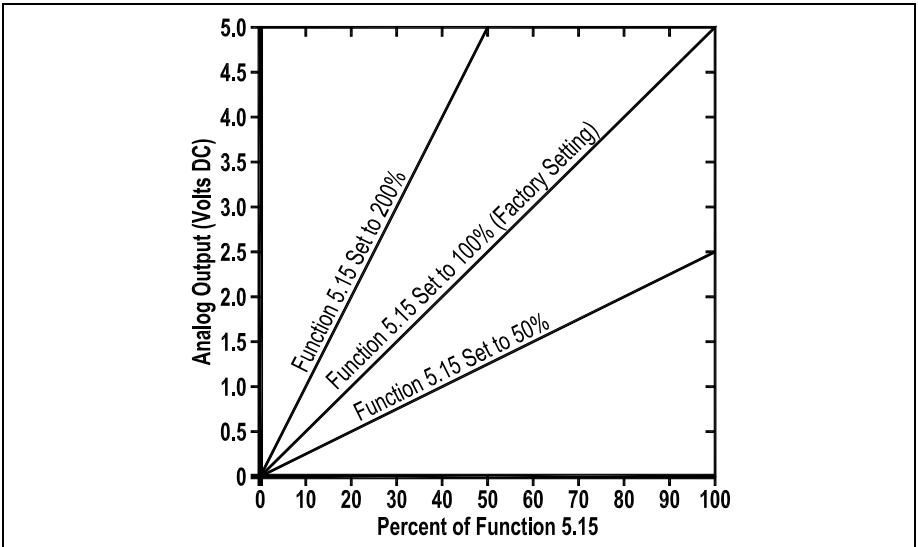
An Analog Output is provided, which puts out a 0 – 5 Volt DC signal and will linearly follow the parameter programmed in Analog Output 1 Mode (Function 5.14). It can be used to monitor Output Frequency, Set Frequency, Motor Voltage, Bus Voltage, and Motor Current. See Figure 34, for connections and drive programming. See Figure 35, for Analog Output 1 Gain settings (factory set to 100%).

**FIGURE 34**  
**ANALOG OUTPUT**  
**CONNECTIONS AND DRIVE PROGRAMMING**



\*Factory setting.

**FIGURE 35**  
**ANALOG OUTPUT GAIN**



## 9 HIGH VOLTAGE DIELECTRIC WITHSTAND TESTING (HI-POT TEST)

Testing agencies such as UL, CSA, etc., usually require that equipment undergo a hi-pot test. In order to prevent catastrophic damage to the drive, which has been installed in the equipment, the following procedure is recommended. A typical hi-pot test setup is shown in Figure 36.

**All drives have been factory hi-pot tested in accordance with UL requirements.**

**CAUTION! This is an AC Hi-Pot Test for all models except models with built-in RFI (EMI) filters. On Models KBDF-23F, 24F, 27F only perform a DC Hi-Pot Test.**



**WARNING! All equipment AC Line inputs must be disconnected from the AC power.**

Connect all equipment AC power input lines together and connect them to the H.V. lead of the Hi-Pot Tester.

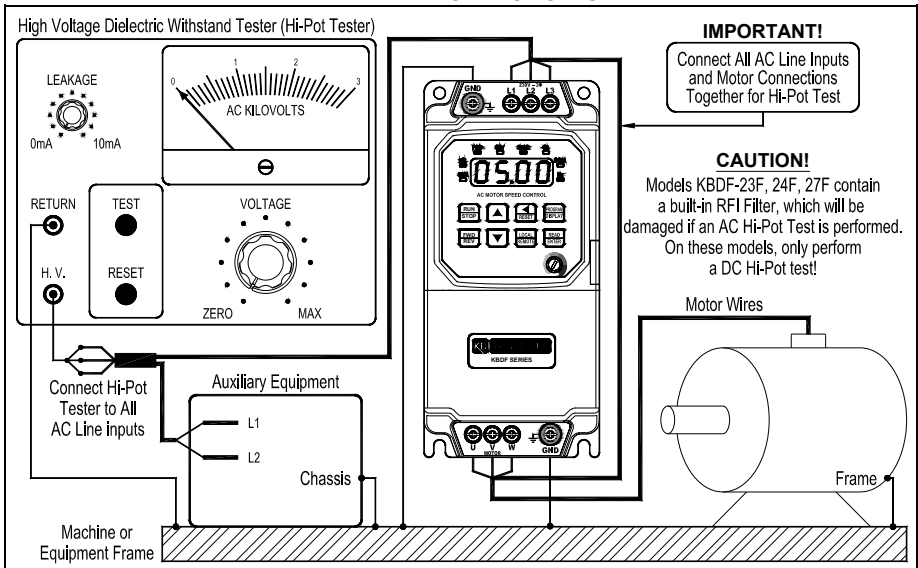
Connect the RETURN of the Hi-Pot Tester to the frame on which the drive and other auxiliary equipment are mounted.

The Hi-Pot Tester must have an automatic ramp-up to the test voltage and an automatic ramp-down to zero voltage.

**Note:** If the Hi-Pot Tester does not have automatic ramping, then the hi-pot output must be manually increased to the test voltage and then manually reduced to zero. This procedure must be followed for each machine being tested. A suggested Hi-Pot Tester is Slaughter Model 2550.

**CAUTION!** Instantly applying the hi-pot voltage will cause irreversible damage to the drive, which will void the warranty.

**FIGURE 36**  
**TYPICAL HI-POT TEST SETUP**



---

## 10 DRIVE OPERATION

---

Before operating the drive, read Section 10.3, for instructions on the Keypad Operation. See Figure 3, on page 16, for the keypad layout. The 4-digit display can indicate various functions of the drive: Set Frequency, Motor RPM, Output Current and Voltage, Custom Units, Function Numbers, Function Codes or Values, and Fault Codes. See Section 11, on page 52.

See Section 12, on page 54, for information on programming the drive. If an error message appears while programming the drive, see Section 11, on page 52.

### 10.1 START-UP PROCEDURE

After the drive has been properly setup and all connections completed, the start-up procedure can begin. If the AC power has been properly brought to the drive, the LEDs will indicate the drive's status, as described in Table 4, on page 17. See Section 11, on page 52, for the Digital Readout Codes.

To start the drive, press the RUN Key. The motor will begin to accelerate to the Set Frequency. The factory set frequency is 05.00 Hz.

### 10.2 LOCAL/REMOTE OPERATION

The drive can be used for Local (Keypad) or Remote Operation. In this mode, the drive frequency setting can be toggled between the Keypad and a process signal using the LOCAL/REMOTE Key.

*To disable the Local/Remote toggling feature, see Function 2.03.*

**Note:** *The drive will power up in the mode it was set in before it was powered off. If the drive was in Local (Keypad) Operation (factory setting), it will power up in Local (Keypad) Operation. If the drive was set for Remote Operation, it will power up in Remote Operation.*

**Application Note:** The STOP Key will always stop the drive whether it is in Local (Keypad) operation or Remote Operation.



**WARNING!** The STOP Key is never to be used as safety disconnect since it is not fail-safe. Use only the AC Line for this purpose.

### 10.3 KEYPAD DESCRIPTION

The Keypad has eight (8) keys, which are used to program drive functions. The eight (8) LEDs provide indication of the drive's operational status. A Main Speed Potentiometer is also provided to set the Drive Frequency (Function 2.00 set to "0001"). See Table 4, on page 17.

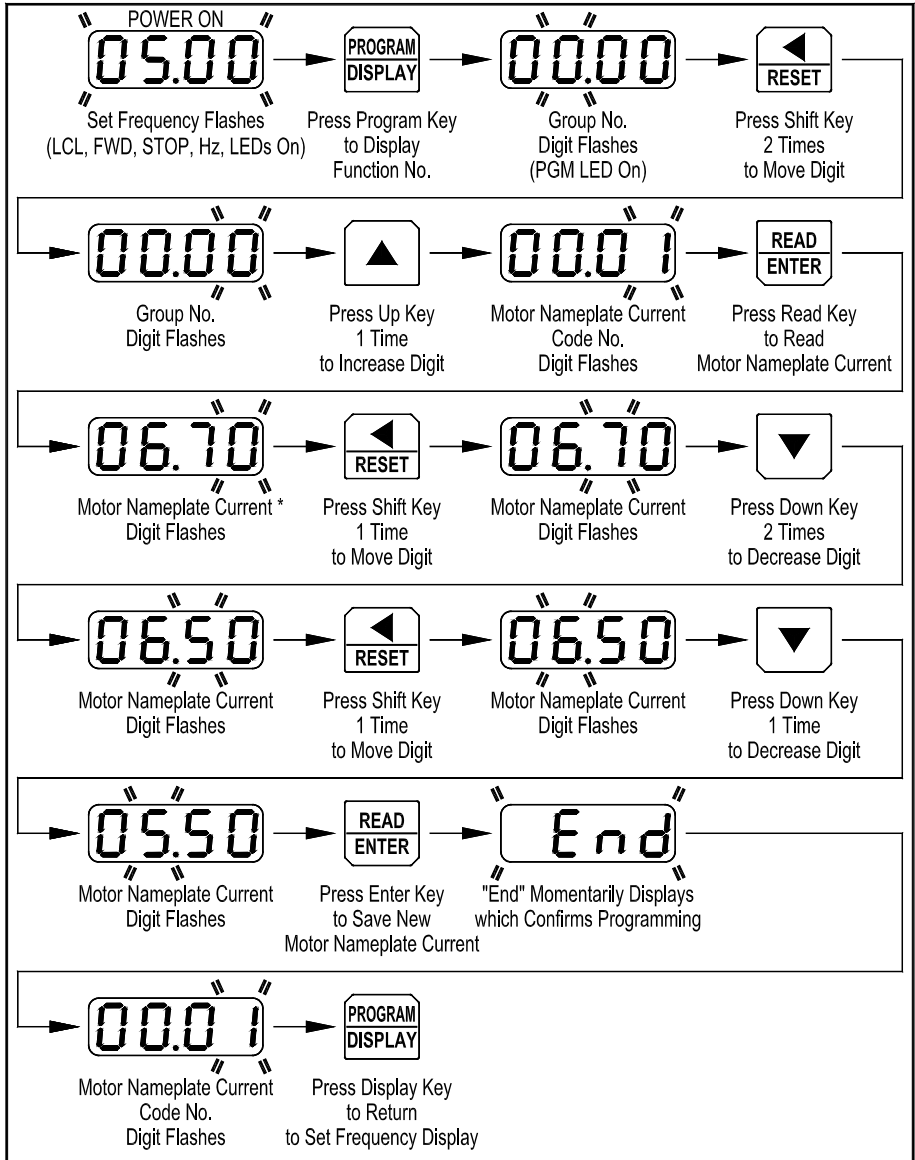
**Note:** *To avoid damage, never operate the keypad with a screwdriver or other sharp-ended tool.*

## 10.4 FLOW CHARTS FOR IMPORTANT PROGRAMMING FUNCTIONS

See Figures 37 – 44, on pages 45 – 51, for the flow charts to program important functions. The flow charts also serve as a guide to understand the programming procedure.

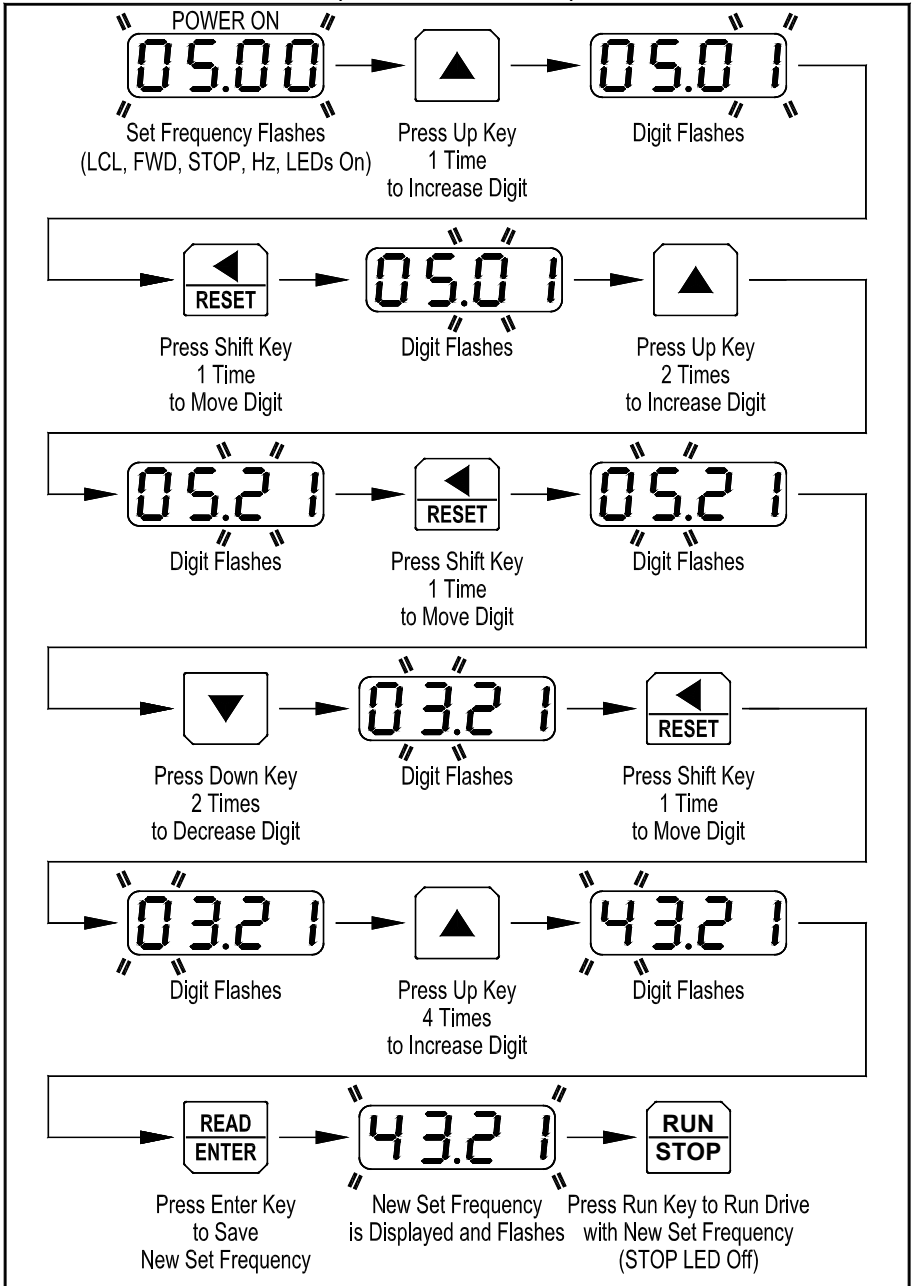
**Note:** See Table 10, on pages 52 and 53, for a description of the Digital Readout codes.

**FIGURE 37**  
**FLOW CHART TO PROGRAM MOTOR CURRENT FROM 6.7 AMPS TO 5.5 AMPS**

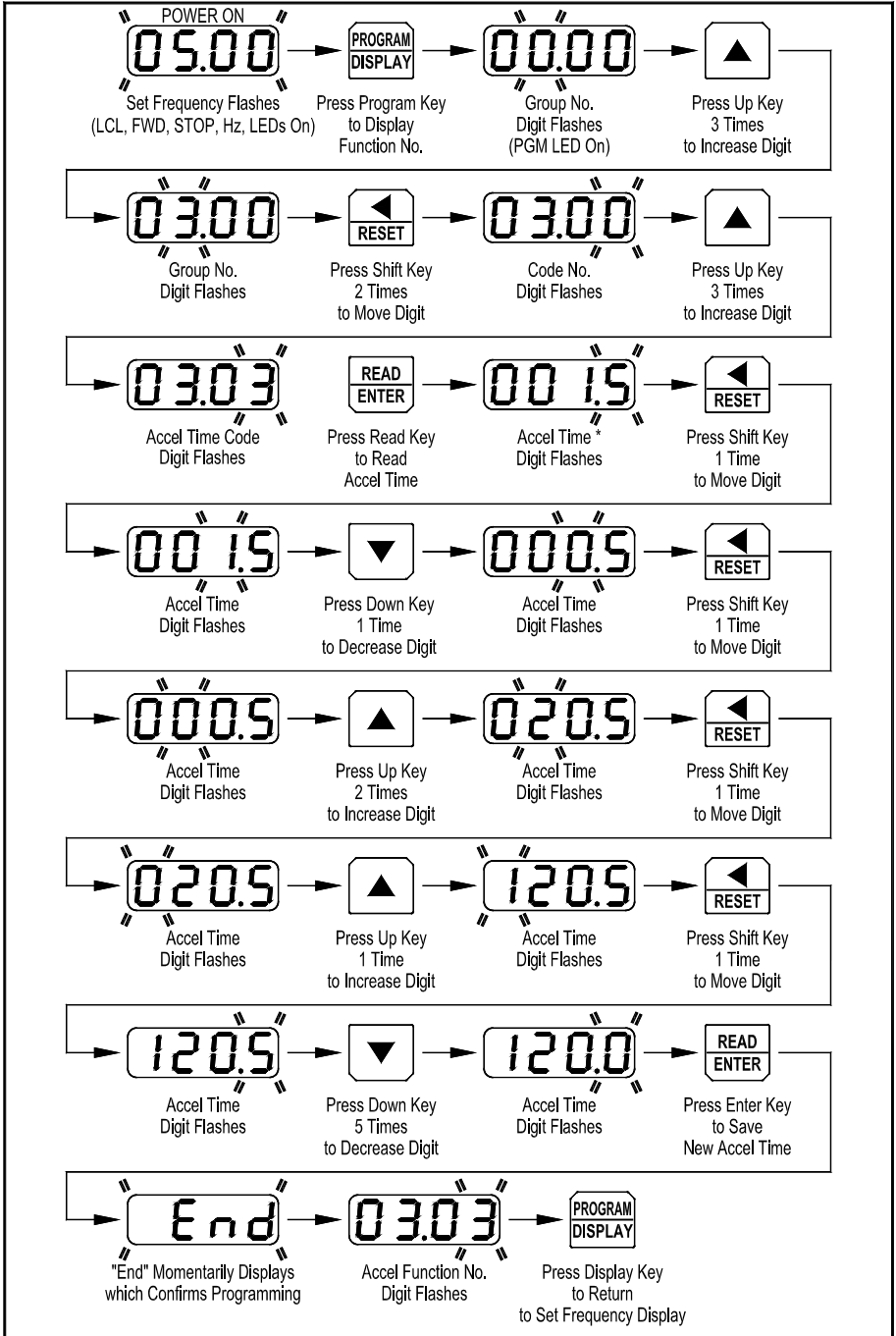


\*Rating shown is for Models KBDF-27, KBDF-27F, KBDF-27D (2 HP, (1.5 kW)), KBDF-29 (1-Phase). See Table 3, on page 15, for the factory setting of Function 0.01 for all other models.

**FIGURE 38**  
**FLOW CHART TO CHANGE SET FREQUENCY FROM 5.00 Hz TO 43.21 Hz\***  
**(DRIVE IN STOP MODE)**

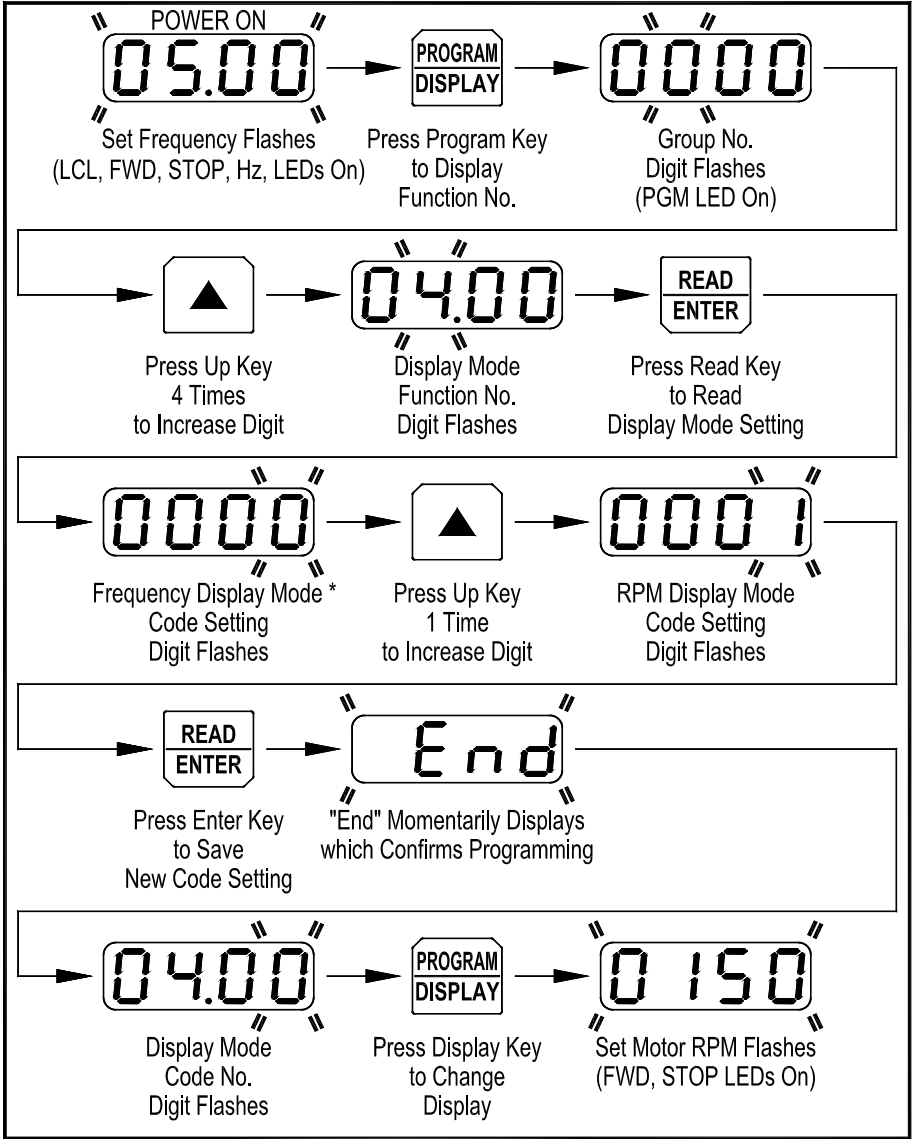


*\*If Function 2.02 is set to "0000", frequency change requires pressing the ENTER Key. Throughout this sequence, you must proceed to the next step within 20 seconds, before the "Press Enter Key" step, or the display will revert back to "0500". The new value will be stored in Function 3.00.*

**FIGURE 39****FLOW CHART TO PROGRAM ACCEL TIME FROM 1.5 SECONDS TO 120 SECONDS**

\*The factory setting of Accel Time (Function 3.03) is "1.5" seconds. Therefore, the left digits must be changed first since an Accel setting of "000.0" is not allowed.

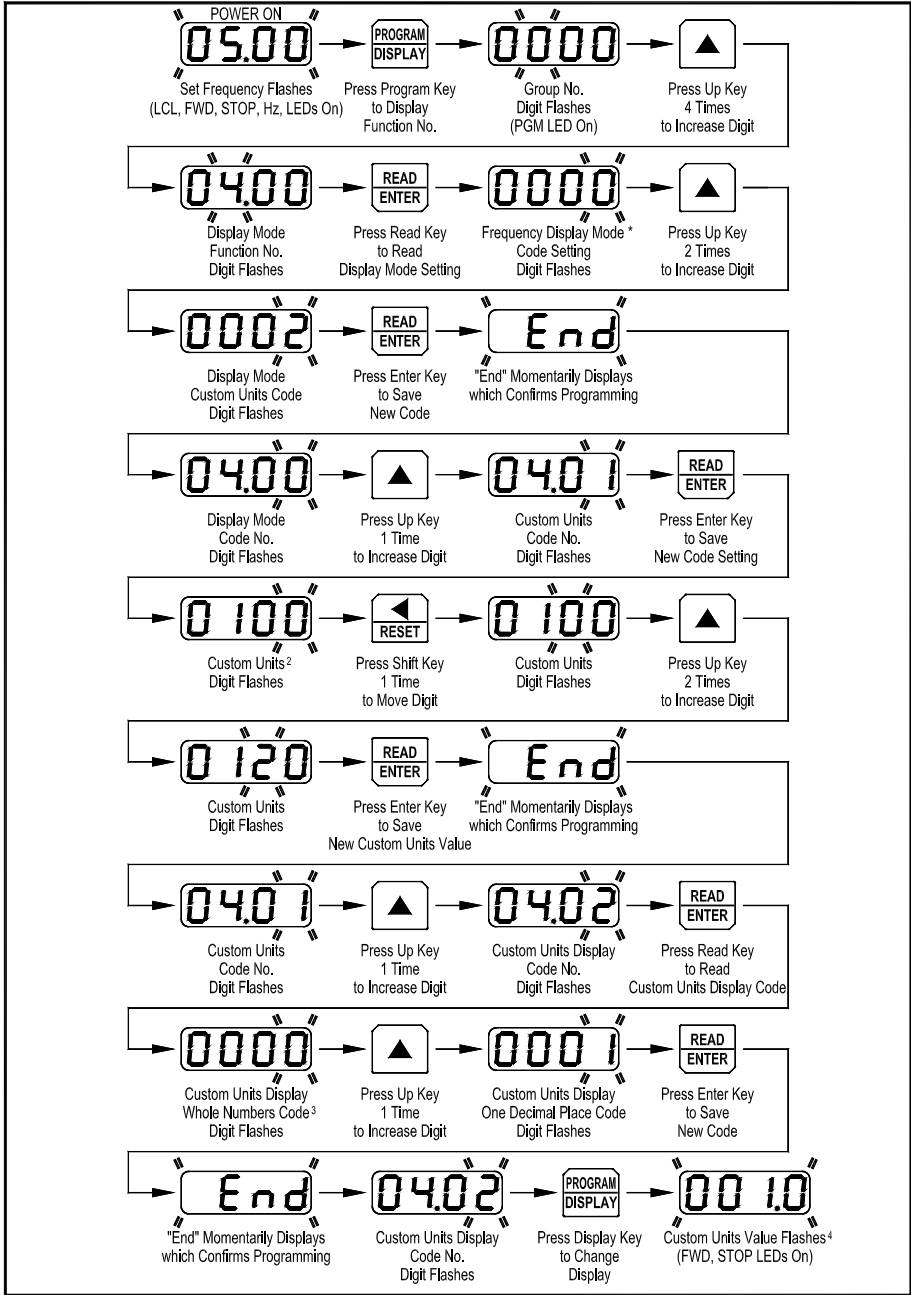
**FIGURE 40**  
**FLOW CHART TO PROGRAM THE DRIVE TO DISPLAY MOTOR RPM**



\*The factory setting of display Mode (Function 4.00) is Frequency ("0000").

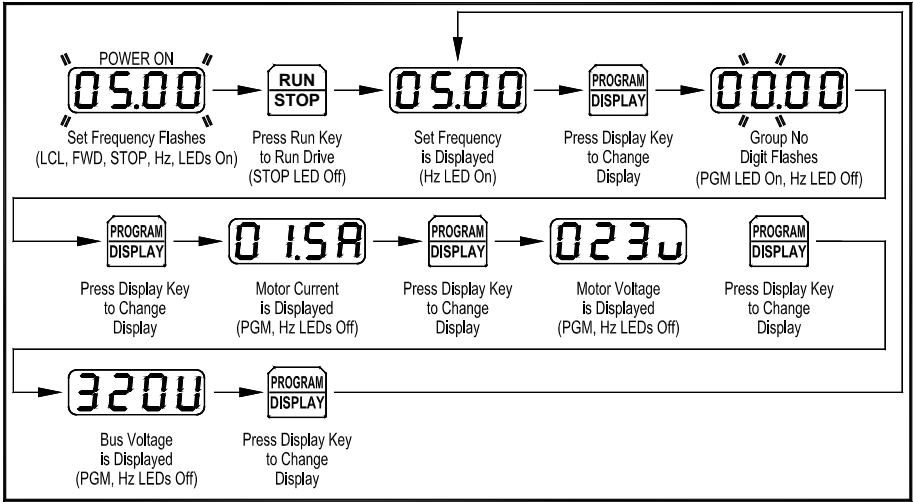


**FIGURE 41**  
**FLOW CHART TO PROGRAM THE DRIVE TO DISPLAY CUSTOM UNITS "012.0"**



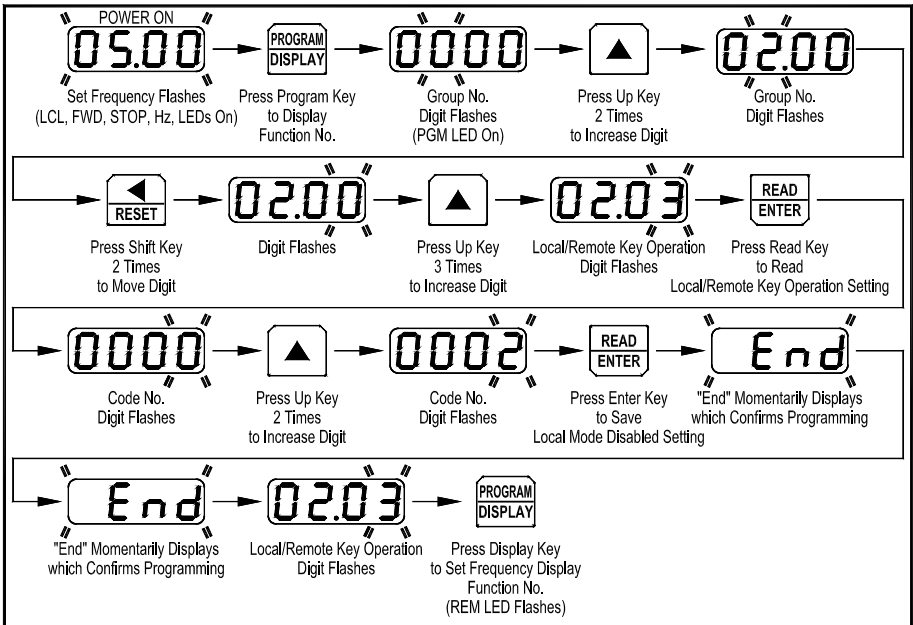
**Notes:** 1. The factory setting of Display Mode (Function 4.00) is Frequency ("0000"). 2. The factory setting of Custom Units Significant Digits (Function 4.01) is "0100". 3. The factory setting of Custom Units Display (Function 4.02) is Whole Numbers ("0000"). 4. The Custom Unit setting "012.0" will be displayed at full speed.

**FIGURE 42**  
**FLOW CHART SHOWING MOTOR CURRENT, MOTOR VOLTAGE, AND BUS VOLTAGE**  
**ADDED TO THE BASIC DISPLAY\***



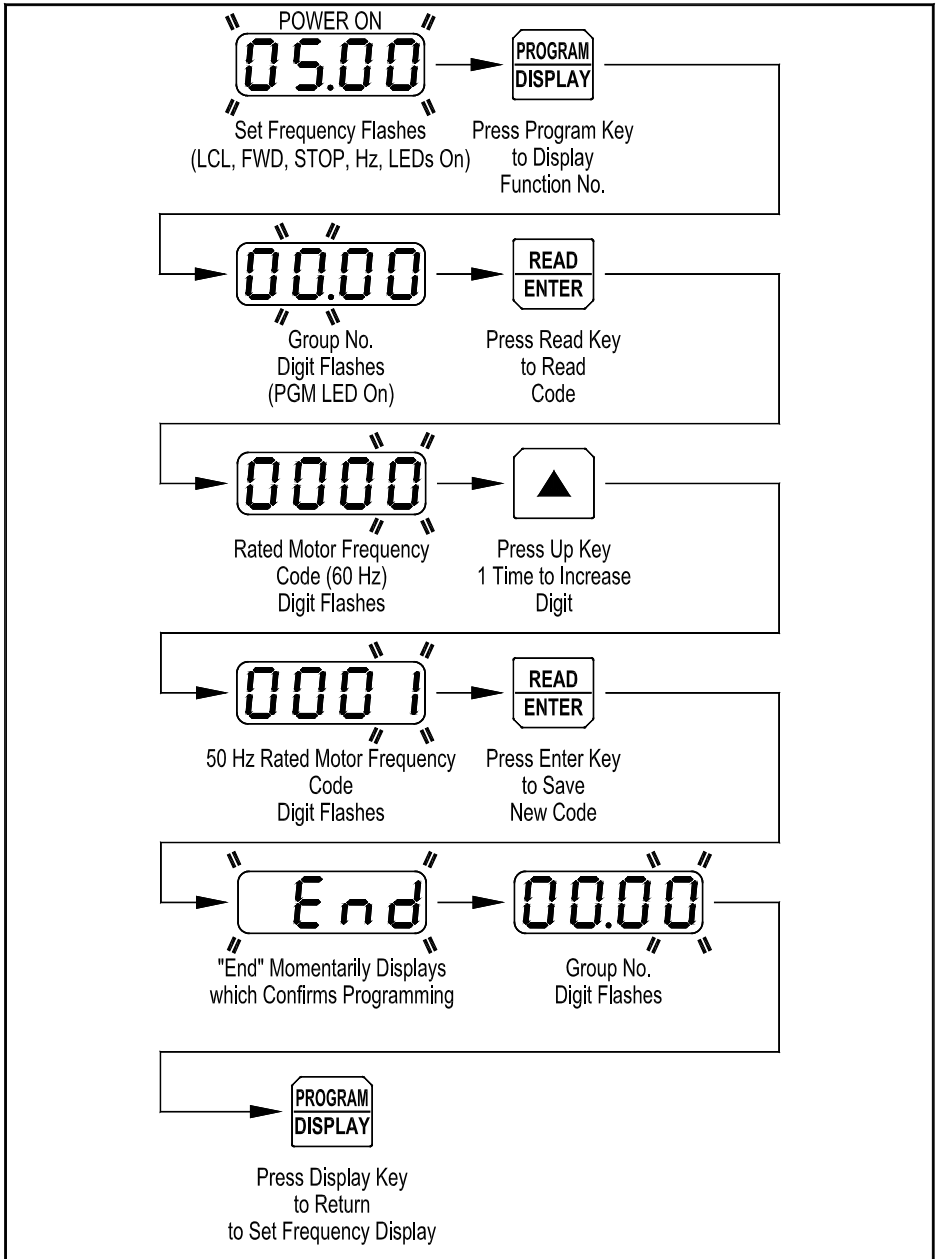
\*Functions 4.04, 4.05, and 4.06 set to "0001".

**FIGURE 43**  
**FLOW CHART TO PROGRAM THE DRIVE FOR REMOTE OPERATION ONLY\***



\*Disables Local (Keypad) Operation.

**FIGURE 44**  
**FLOW CHART TO PROGRAM THE DRIVE FOR 50 Hz MOTORS**



## 11 4-DIGIT DISPLAY READOUT CODES

The 4-digit display provides readout of drive status, operating parameters, and faults. See Table 10, below and on page 54, for the Digital Readout Codes displayed and their descriptions.



**WARNING!** Do not depend on the LEDs or the 4-Digit Display to no longer be illuminated as a guaranteed power off condition. Be sure that the main power switch or circuit breaker is in the "OFF" position before servicing the drive.

**TABLE 10**  
**DIGITAL READOUT CODES**

Display	Description
	<b>Drive Stopped:</b> Indicates that the drive is in the Stop Mode. Function 4.03 set to "0001".
	<b>Parameter Changed:</b> Momentarily flashes. Indicates that a parameter has been successfully changed.
	<b>Function No.:</b> Consists of a Group No. (digits on the left side of the decimal point) and a Group Code No. (digits on right side of decimal point).
	<b>Motor Current Display:</b> When the display is set to show Motor Current, the format will be "XX.XA". Function 4.04 set to "0001".
	<b>Motor Voltage Display:</b> When the display is set to show Motor Voltage, the format will be "XXXu". Function 4.05 set to "0001".
	<b>Bus Voltage Display:</b> When the display is set to show Bus Voltage, the format will be "XXXU". Function 4.06 set to "0001".
	<b>Low Voltage Trip:</b> Indicates that the AC line input voltage is below the Undervoltage Trip Point specified in Table 3, on page 15.
	<b>Low Voltage Recovery:</b> Indicates that a Low Voltage Trip occurred and the AC line input voltage has returned to within the operating range specified in Table 3, on page 15.
	<b>Overvoltage Trip:</b> Indicates that the AC line input voltage is above the Overvoltage Trip Point specified in Table 3, on page 15.
	<b>Overvoltage Recovery:</b> Indicates that an Overvoltage Trip occurred and the AC line input voltage has returned to within the operating range specified in Table 3, on page 15.
	<b>Overload Trip (<math>I^2t</math> Timeout):</b> Indicates that the motor has been overloaded for an extended period of time.
	<b>External Fault Trip:</b> Indicates that an external fault has occurred at one of the MFITs. Functions 7.00 – 7.06 set to "0008" or "0012".

**TABLE 10**  
**DIGITAL READOUT CODES (CONTINUED)**

Display	Description
<b>-SC-</b>	Short Circuit Fault: Indicates that the drive detected a short circuit at the motor (phase-to-phase).
<b>-PL-</b>	<b>AC Line Phase Loss Detection:</b> Indicates that the drive has detected a loss of one of the phases in the 3-phase AC line input applied to Models KBDF-23P, 24P, 27P, 29, 42, 43, 45, 48.
<b>Err 1</b>	<b>Data Enter Error:</b> Indicates that the drive is in the Program Mode and a non-valid parameter change has been attempted.
<b>Err 2</b>	<b>Communication Watchdog Trip:</b> A valid communication message was not received within the time specified in Function 10.05.
<b>Err 3</b>	<b>IODF Error:</b> Indicates that the drive has lost communication with the IODF.
<b>Err 5</b>	<b>Key Error:</b> The UP and Down Keys are disabled for editing the frequency or the FWD/REV Key is disabled for changing direction.
<b>EE-1</b>	<b>On-Board Memory Error:</b> The On-Board Memory on the Drive is not detected.
<b>EE-2</b>	<b>Memory Module Error:</b> The Memory Module is not detected.
<b>EE-3</b>	<b>Horsepower Code Error:</b> The program selected is not compatible with the Drive.
<b>EE-4</b>	<b>Program Revision Error:</b> The program selected is not compatible with the Drive.
<b>EE-5</b>	<b>Checksum Error:</b> The program selected is corrupt.
<b>EE-6</b>	<b>Program Location Blank Error:</b> The program location selected does not contain any data.

**Fault Recovery:** The drive monitors many faults. See Function 1.05, on page 56, for restarting the drive after a fault has been cleared. See Table 4, on page 17, for descriptions of the Diagnostic LEDs. See Appendix A, on page 64, for IODF faults.

**Drive Faults:** Undervoltage ("LU-"), Overvoltage ("OU-"), Short Circuit at the motor (phase-to-phase) ("SC-"), I<sup>2</sup>t or I\*t Fault ("OL-t"), and Phase Loss Protection (Models KBDF-23P, 24P, 27P, 29, 42, 43, 45, 48) ("PL-").

## 12 PROGRAMMABLE FUNCTION LIST (Rev X.XX)

All functions have been factory set, as shown in the tables on pages 55 – 63. The *Detailed Programmable Function List* is available – contact our Sales Department.

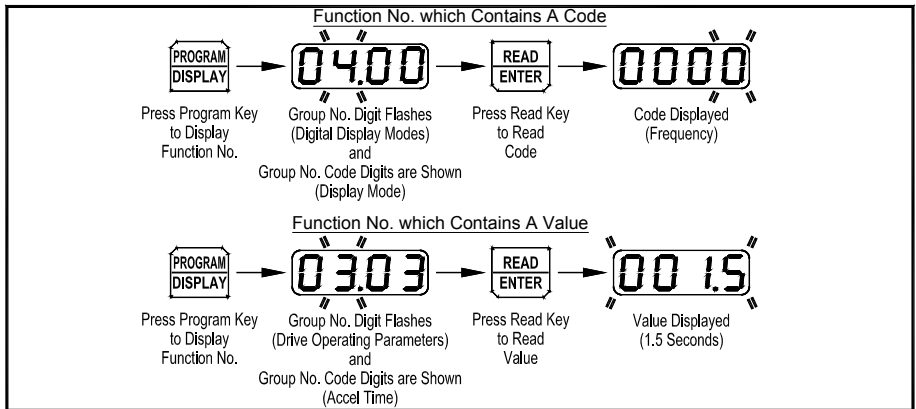
**Programming Mode:** When the drive is put into the Programming Mode (see Figure 45) a Function No. will be displayed. A Function No. consists of a Group No. (digits on the left side of the decimal point) and a Group No. Code (digits on the right side of the decimal point). The digits can be changed using the Up and Down Keys. The Left Shift Key is used to move the changeable digit.

When the READ Key is pressed, either a Code or Value will be displayed. Codes have specific descriptions. Values have numeric ranges.

**Application Note:** The programming of the drive can be performed without a motor connected. On drives with 3-phase AC line input requirements, the programming can be performed with single-phase AC line input. The drive's Phase Loss Detection will not trip the drive without the motor connected.

To program multiple drives, the optional Programming Kit (Part No. XXXX) can be used to upload the drive program and facilitate downloading it to multiple drives. The optional Memory Module (Part No. 9634) can be used to program the drive and/or for cloning multiple drives.

**FIGURE 45**  
**FUNCTION NO. DESCRIPTION**



### Programmable Function Groups

Function Group No.	Description
0	Motor and Drive Parameters
1	Run/Stop Mode
2	Frequency Control
3	Drive Operating Parameters
4	Digital Display Modes
5	Multi-Function Output Relay and Output Signal Operation
6	Drive Status and Reset
7	Multi-Function Input Terminals
8	PID
9	Analog Input Signal Operation
10	Communication Mode (DIDF Option Board Required)
11	Advanced Vector Control (Encoder and DIDF Option Board Required)
12	Reserved Functions (OEM Only)

## Function Group 0: Motor and Drive Parameters

Function No.	Description	Range/Code	Factory Setting	User Setting
0.00 *	Rated Motor Frequency (Hz)	<b>0000:</b> 60 Hz <b>0001:</b> 50 Hz <b>0002:</b> Special (Set by 0.05)	0000	
0.01 *	Motor Nameplate Current (Amps)	—	(1)	
0.02 *	Reserved	—	—	
0.03 *	Torque Mode	<b>0000:</b> Constant Torque (Machinery) <b>0001:</b> Variable Torque (HVAC)	0000	
0.04 *	GFCI Operation (2)	<b>0000:</b> GFCI Operation Disabled <b>0001:</b> Operation with Standard GFCI <b>0002:</b> Operation with Sensitive GFCI	0000	
0.05 *	Motor Nameplate Frequency (Hz) (3,4)	<b>30 – 240</b>	60, 50	
0.06 *	Motor Nameplate Voltage (% Drive Output) (5)	<b>0 – 100</b>	100 (6)	

**Notes:** (1) Factory Setting is the drive rated output current. This function is used to enter the Motor Nameplate Rated Current, which allows proper operation of the  $I^2t$  Motor Overload Protection. (2) GFCI operation overrides the Switching Frequency set by Function 3.15. (3) When the drive is set for 50 Hz motors (Function 0.00 set to code "0001"), the Motor Frequency factory setting will automatically reset to 50 Hz. (4) The Motor Frequency for standard 50 Hz or 60 Hz motors is set by Function 0.00. For custom motors (e.g., 100 Hz) set Function 0.00 to code "0002" and Function 0.05 to the Motor Nameplate Rated Frequency. (5) This function is used for motors with non-standard nameplate rated voltage (e.g., 80 Volts AC). (6) The factory set output of the drive is 100% of the AC Line input voltage. In 60 Hz Mode (Function 0.00 set to code "0000") the drive output will be 230 Volts, maximum, for 230 Volt motors. In 50 Hz Mode (Function 0.00 set to code "0001") the drive output will be 220 Volts, maximum, for 220 Volt motors.

\*Functions which can only be changed while the drive is in the Stop Mode.

## Function Group 1: Run/Stop Mode

Function No.	Description	Range/Code	Factory Setting	User Setting
1.00 *	Run/Stop-Forward/Reverse Control <sup>(1)</sup>	<b>0000:</b> Keypad <b>0001:</b> External Contacts <b>0002:</b> Communication <sup>(2)</sup>	0001	
1.01 *	Forward/Reverse Control	<b>0000:</b> Instant Reverse <b>0001:</b> Stop Command Must be Given Prior to Reverse Command <b>0002:</b> Reverse Command Disabled <b>0003:</b> Forward Command Disabled	0000	
1.02 *	Motor Direction	<b>0000:</b> Forward <b>0001:</b> Reverse	0000	
1.03 *	Start Command	<b>0000:</b> Accelerates to Last Set Frequency <b>0001:</b> Accelerates to Lower Frequency Limit (See 3.01)	0000	
1.04 *	Restart Mode	<b>0000:</b> Spin Start <b>0001:</b> Stop before Restart	0000	
1.05 *	Auto/Manual Start Mode	<b>0000:</b> Manual Start Mode <b>0001:</b> Manual Start with Ride-Through (Set by 1.06) <b>0002:</b> Auto Start After Undervoltage Fault Clears <b>0003:</b> Auto Start All Faults (Except I <sup>2</sup> t, I•t, and Short Circuit Faults) <b>0004:</b> Auto Start All Faults (Except Short Circuit Fault) <sup>(3)</sup>	0000	
1.06 *	Ride-Through Time (Seconds)	<b>0.0 – 2.0</b>	0.5	
1.07 *	Number of Restart Attempts	<b>0 – 10</b>	3	
1.08 *	Start Delay Time (Seconds)	<b>0 – 240</b>	0	
1.09 *	Stop Mode	<b>0000:</b> Regenerate-to-Stop <b>0001:</b> Coast-to-Stop <b>0002:</b> Regeneration with Injection Brake-to-Stop (Set by 1.11 – 1.13)	0000	
1.10 *	Holding Torque in Stop Mode (%)	<b>0 – 10</b>	0	
1.11	Injection Brake Start Frequency (Hz)	<b>0.00 – 240.0</b>	0.00	
1.12	Injection Brake Level (%)	<b>0 – 30</b>	0	
1.13	Injection Brake Time (Seconds)	<b>0.0 – 25.5</b>	0.0	

**Notes:** (1) Sets the source for the Run/Stop-Fwd/Rev in Remote mode (see Function 2.03). (2) DIDF Option Board required. (3) For Auto Start, Function 1.07 must be set to greater than "0" (factory setting is "3").

\*Functions which can only be changed while the drive is in the Stop Mode.



## Function Group 2: Frequency Control

Function No.	Description	Code	Factory Setting	User Setting
2.00 *	Local Frequency Control	<b>0000:</b> Keypad <b>0001:</b> Built-In Potentiometer	0000	
2.01 *	Remote Frequency Control**	<b>0000:</b> Analog Signal 1 <b>0001:</b> Analog Signal 2 <sup>(1)</sup> <b>0002:</b> Communication <sup>(2)</sup> <b>0003:</b> Up/Down Using MFITs	0000	
2.02 *	Up Key, Down Key Operation Mode	<b>0000:</b> Frequency Change Requires Enter Command <b>0001:</b> Direct Frequency Change <b>0002:</b> Keypad Disable	0000	
2.03 *	Local/Remote Key Operation	<b>0000:</b> Local/Remote Enabled (Frequency Control and Run/Stop-Fwd/Rev) <b>0001:</b> Local/Remote Enabled (Run/Stop-Fwd/Rev Only) <b>0002:</b> Local Mode Disabled <b>0003:</b> Remote Mode Disabled	0000	

**Notes:** (1) IODF Option Board required. (2) DIDF Option Board required.

\*Functions which can only be changed while the drive is in the Stop Mode.

\*\*Preset Frequency Operation is performed using the Multi-Function Input Terminals.

## Function Group 3: Drive Operating Parameters

Function No.	Description	Range/Code	Factory Setting	User Setting
3.00	Stored Set Frequency (Hz)	<b>0.00 – 240.0</b>	5.00	
3.01	Lower Frequency Limit (Hz)	<b>0.00 – 240.0</b>	0.00	
3.02	Upper Frequency Limit (Hz) <sup>(1)</sup>	<b>0.00 – 240.0</b>	60.0, 50.0	
3.03	Accel Time (Seconds) <sup>(2)</sup>	<b>0.1 – 180.0</b>	1.5	
3.04	Decel Time (Seconds) <sup>(2)</sup>	<b>0.3 – 180.0</b>	1.5	
3.05	S-Curve Time Accel (Seconds) <sup>(2)</sup>	<b>0.0 – 30.0</b>	0.0	
3.06	S-Curve Time Decel (Seconds) <sup>(2)</sup>	<b>0.0 – 30.0</b>	0.0	
3.07 *	Skip Frequency (Hz)	<b>0.00 – 240.0</b>	0.00	
3.08 *	Skip Frequency Bandwidth ( $\pm$ Hz)	<b>0.00 – 2.00</b>	0.00	
3.09 *	Motor Overload Protection	<b>0000:</b> I <sup>2</sup> t with Current Limit (CL is 160% of Function 0.01) <b>0001:</b> I <sup>2</sup> t with Current Limit (CL is 120% of Function 0.01)	0000	
3.10 *	I <sup>2</sup> t with Current Limit Trip Time (Seconds)	<b>1.0 – 20.0</b>	6.0	
3.11–3.12	Reserved	—	—	
3.13	Boost Mode	<b>0000:</b> Auto <b>0001:</b> Fixed (See 3.14)	0000	
3.14	Boost Value (%)	<b>0.0 – 28.0</b>	7.0	
3.15 *	Switching Frequency (kHz)	<b>0000:</b> 8 <b>0001:</b> 10 <b>0002:</b> 12	0000	
3.16	Flux Vector Compensation (%)	<b>0.0 – 10.0</b>	5.0	
3.17	Reserved	—	—	
3.18	Fan Control <sup>(3)</sup>	<b>0000:</b> Auto Run (Temperature Control) <b>0001:</b> Run Mode Only <b>0002:</b> Run Continuously <b>0003:</b> Fan Off	0000	
3.19–3.24	Reserved	—	—	

**Notes:** (1) When the drive is set for 50 Hz motors (Function 0.00 set to code "0001"), the Upper Frequency Limit factory setting will automatically reset to 50 Hz. (2) Time set for Functions 3.03 and 3.04 must be equal to or greater than the time set for Functions 3.05 and 3.06, respectively.

(3) Models with fan installed only.

\*Functions which can only be changed while the drive is in the Stop Mode.

#### Function Group 4: Digital Display Modes

Function No.	Description	Range/Code	Factory Setting	User Setting
4.00	Display Mode	<b>0000:</b> Frequency <b>0001:</b> RPM <sup>(1)</sup> <b>0002:</b> Custom Units (Default is "0100")	0000	
4.01	Custom Units (Significant Digits)	<b>0 – 9999</b>	100	
4.02	Custom Units Display	<b>0000:</b> Whole Numbers (XXXX) <b>0001:</b> One Decimal Place (XXX.X) <b>0002:</b> Two Decimal Places (XX.XX) <b>0003:</b> Three Decimal Places (X.XXX)	0000	
4.03	Display in Stop Mode	<b>0000:</b> Displays Last Run Setting <b>0001:</b> Displays "Stop" <b>0002:</b> Displays "0000"	0000	
4.04	Motor Current Display <sup>(2, 3)</sup>	<b>0000:</b> Disabled <b>0001:</b> Enabled	0000	
4.05	Motor Voltage Display <sup>(2, 3)</sup>	<b>0000:</b> Disabled <b>0001:</b> Enabled	0000	
4.06	Bus Voltage Display <sup>(2, 3)</sup>	<b>0000:</b> Disabled <b>0001:</b> Enabled	0000	
4.07–412	Reserved	—	—	

**Notes:** (1) Based on 4-pole motor. (2) The Display Key is used to toggle between displays. (3) If Motor Current Display is enabled, the display will show "XX.XA". If Motor Voltage Display is enabled, the display will show "XXXu". If Bus Voltage Display is enabled, the display will show "XXXU". If Motor Torque Output is enabled, the display will show "XXXt". If Motor Power Output is enabled, the display will show "XXXP".

#### Function Group 5: Multi-Function Output Relay Operating Mode and Output Signal Operation

Function No.	Description	Range/Code	Factory Setting	User Setting
5.00	Multi-Function Output Relay 1 (TB2 on Drive)	<b>0000:</b> Run <b>0001:</b> Fault <sup>(2)</sup> <b>0002:</b> Target Frequency (5.03 ± 5.04) <b>0003:</b> Frequency Threshold Level (> 5.03 – 5.04) <sup>(3)</sup>	0000	
5.01	Multi-Function Output Relay 2 <sup>(1)</sup> (TB3 on IODF)	<b>0004:</b> Frequency Threshold Level (< 5.03 + 5.04) <sup>(4)</sup>	0001	
5.02	Multi-Function Open Collector Output <sup>(1)</sup> (Terminal 13 of TB1 on IODF)	<b>0005:</b> I <sup>2</sup> t or I+t Fault <b>0006:</b> Load Loss (See 5.05) <sup>(5)</sup> <b>0007:</b> External Fault	0005	
5.03	Frequency Reached (Hz)	<b>0.00 – 240.0</b>	0.00	
5.04	Frequency Bandwidth (± Hz)	<b>0.00 – 30.00</b>	1.00	
5.05	Load Loss Threshold <sup>(5)</sup> (% Motor Current, Set by Function 0.01)	<b>25 – 90</b>	60	
5.06–5.13	Reserved	—	—	
5.14	Analog Output 1 Mode (Terminals 11, 12) (0 – 5 Volts DC)	<b>0000:</b> Output Frequency <b>0001:</b> Set Frequency <b>0002:</b> Motor Voltage <b>0003:</b> Bus Voltage <b>0004:</b> Motor Current	0000	
5.15	Analog Output 1 Gain (%)	<b>0 – 200</b>	100	

**Note:** (1) IODF Option Board required. (2) The Multi-Function Output Relay contacts and Open Collector Outputs will change state due to all Faults and Recovered Faults. (3) The Multi-Function Output Relay contacts and Open Collector Outputs will activate above the setting in Function 5.03 and deactivate below the setting in Function 5.03 minus the setting in Function 5.04. (4) The Multi-Function Output Relay contacts and Open Collector Outputs will activate below the setting in Function 5.03 and deactivate above the setting in Function 5.03 plus the setting in Function 5.04. (5) The Load Loss Threshold function is not functional during acceleration/deceleration or Stop Mode.

## Function Group 6: Drive Status and Reset

Function No.	Description	Code	Factory Setting	User Setting
6.00 *	Drive ID	—	—	
6.01 *	Software Version	—	—	
6.02 *	Drive Horsepower	—	—	
6.03 *	Fault Log 1	—	—	
6.04 *	Fault Log 2	—	—	
6.05 *	Fault Log 3	—	—	
6.06–6.09	Reserved	—	—	
6.10 **	Reset Drive to Factory Setting	<b>1110</b> : 50 Hz Operation <b>1111</b> : 60 Hz Operation <b>1010</b> : Default Program (See 6.11 and 6.12)	0000	
6.11 **	Program Location	<b>0000</b> : On-Board Memory <b>0001</b> : Memory Module (Removable)	0000	
6.12 **	Program Number	<b>0001</b> : Program 1 <b>0003</b> : Program 3 <b>0002</b> : Program 2 <b>0004</b> : Program 4	0001	
6.13 **	Memory Copy Operation	<b>0001</b> : Copy from Memory Module to On-board Memory <b>0002</b> : Copy from On-board Memory to Memory Module <b>0003</b> : Copy Active Program to On-Board Memory <b>0004</b> : Copy Active Program to Memory Module	0000	
6.14 **	On-board Memory Program Number	<b>0001</b> : Program 1 <b>0003</b> : Program 3 <b>0002</b> : Program 2 <b>0004</b> : Program 4	0001	
6.15 **	Memory Module Program Number	<b>0001</b> : Program 1 <b>0003</b> : Program 3 <b>0002</b> : Program 2 <b>0004</b> : Program 4	0001	
6.16 **	Memory Module Operation	<b>0000</b> : Manual Read/Write Operation <b>0001</b> : Automatic Read on Power up	0000	

\*Read only.

\*\*Functions which can only be changed while the drive is in the Stop Mode.

### Function Group 7: Multi-Function Input Terminals

Function No.	Description	Range/Code	Factory Setting	User Setting
7.00 *	Multi-Function Input 1 (Terminal 5) <sup>(1)</sup>	<b>0000</b> : Preset Frequency Operation <sup>(2)</sup> <b>0001</b> : Preset Frequency Operation <sup>(2)</sup>	0000	
7.01 *	Multi-Function Input 2 (Terminal 6) <sup>(1)</sup>	<b>0002</b> : Preset Frequency Operation <sup>(2)</sup> <b>0003</b> : Up Frequency Command (See 7.14)	0001	
7.02 *	Multi-Function Input 3 (Terminal 7) <sup>(1)</sup>	<b>0004</b> : Down Frequency Command (See 7.14)	0002	
7.03 *	Multi-Function Input 4 (Terminal 8) <sup>(1)</sup>	<b>0005</b> : Accel/Decel #2 (See 7.16) <b>0006</b> : Forward/Stop Command <b>0007</b> : Reverse/Stop Command	0009	
7.04 *	Multi-Function Input 5 (Terminal 9) <sup>(1)</sup>	<b>0008</b> : External Fault (N.O. Contact) <b>0009</b> : Reset	0010	
7.05 *	Multi-Function Input 6 (Terminal 14) <sup>(1, 4)</sup>	<b>0010</b> : N.O. Start (2-Wire or 3-Wire Start/Stop)	0003	
7.06 *	Multi-Function Input 7 (Terminal 15) <sup>(1, 4)</sup>	<b>0011</b> : N.C. Stop (3-Wire Start/Stop) <b>0012</b> : External Fault (N.C. Contact)	0004	
7.07	Preset Frequency 1 (Hz)	<b>0.00 – 240.0</b>	10.00	
7.08	Preset Frequency 2 (Hz)	<b>0.00 – 240.0</b>	15.00	
7.09	Preset Frequency 3 (Hz)	<b>0.00 – 240.0</b>	20.00	
7.10	Preset Frequency 4 (Hz)	<b>0.00 – 240.0</b>	25.00	
7.11	Preset Frequency 5 (Hz)	<b>0.00 – 240.0</b>	30.00	
7.12	Preset Frequency 6 (Hz)	<b>0.00 – 240.0</b>	35.00	
7.13	Preset Frequency 7 (Hz)	<b>0.00 – 240.0</b>	40.00	
7.14	Up/Down Frequency Control Mode	<b>0000</b> : Free-Running <sup>(3)</sup> <b>0001</b> : Incremental Change (See 7.15)	0000	
7.15	Increment of Up/Down Frequency (Hz)	<b>0.01 – 30.00</b>	1.00	
7.16	Accel/Decel #2 Time (Seconds)	<b>0.3 – 180.0</b>	10.0	
7.17–7.33	Reserved	—	—	

**Note:** (1) Each of the 7 Multi-Function Inputs can be programmed for any of the respective function codes ("0000" – "0012"). (2) Preset Frequencies 1 – 7 are obtained by selecting a specific combination of 3 Multi-Function Input Terminals. The specific frequencies are programmed in Functions 7.07 – 7.13. (3) The rate of change of the "UP" Control for frequency setting, using external contacts, is proportional to the Accel Time setting (Function 3.03). The incremental rate of change of the "DOWN" Control for frequency setting, using external contacts, is proportional to the Decel Time Setting (Function 3.04). (4) IODF Option Board required.

\*Functions which can only be changed while the drive is in the Stop Mode.

### Function Group 8: PID (IODF Option Board Required)

Function No.	Description	Range/Code	Factory Setting	User Setting
8.00–8.10	Reserved	—	—	

## Function Group 9 – Analog Input Signal Operation

Function No.	Description	Range/Code	Factory Setting	User Setting
9.00	Analog Input 1 Gain (%)	0 – 500	100	
9.01	Analog Input 1 Slope	0000: Positive 0001: Negative	0000	
9.02	Analog Input 1 Offset (%)	0 – 100	0	
9.03	Analog Input 1 Type	0000: Unidirectional <sup>(1)</sup> 0001: Bidirectional 0002: PWM <sup>(2)</sup>	0000	
9.04	Analog Input 1 Response Time (mSec)	2 – 10	2	
9.05	Analog Input 2 Gain (%) <sup>(3)</sup>	0 – 500	100	
9.06	Analog Input 2 Slope <sup>(3)</sup>	0000: Positive 0001: Negative	0000	
9.07	Analog Input 2 Offset (%) <sup>(3)</sup>	0 – 100	0	
9.08	Analog Input 2 Response Time (mSec) <sup>(3)</sup>	2 – 10	2	

**Notes:** (1) Can be used for Current Signal input, by setting Jumper J2, on the drive, to the "CUR" position. (2) 0.15 – 1 kHz (0 – 100% duty cycle). (3) IODF Option Board required.

**Function Group 10: Communication Mode (DIDF Option Board Required)**

Function No.	Description	Range/Code	Factory Setting	User Setting
10.00 *	Assigned Comm. Station Number	1 – 247	30	
10.01–10.03	Reserved	—	—	
10.04	Communications Watchdog Timer	0000: Disabled      0001: Enabled	0000	
10.05	Watchdog Timeout (Seconds)	0.50 – 2.00	0.50	
10.06	Reserved	—	—	
10.07	Operational Command	0	0: Stop      1: Run	
		1	0: Forward      1: Reverse	
		2	0: N/A      1: Fault Reset	
		3	0: Local      1: Remote	
		4	0: N/A      1: Preset Frequency 1	
		5	0: N/A      1: Preset Frequency 2	
		6	0: N/A      1: Preset Frequency 3	
		7	0: N/A      1: Preset Frequency 4	
		8	0: N/A      1: Preset Frequency 5	
		9	0: N/A      1: Preset Frequency 6	
		10	0: N/A      1: Preset Frequency 7	
10.08	Drive Status	11 – 15	Reserved	
		0	0: Stop      1: Run	
		1	0: Forward      1: Reverse	
		2	0: Normal      1: Fault	
		3	0: Local      1: Remote	
		4	0: N/A      1: Preset Frequency 1	
		5	0: N/A      1: Preset Frequency 2	
		6	0: N/A      1: Preset Frequency 3	
		7	0: N/A      1: Preset Frequency 4	
		8	0: N/A      1: Preset Frequency 5	
		9	0: N/A      1: Preset Frequency 6	
10	0: N/A      1: Preset Frequency 7			
10.09	Drive Status Description	11 – 15	Reserved	
		00	Normal Operation	
		01	Short Circuit Trip	
		02	Current Limit	
		03	Current Limit Trip	
		04	Undervoltage Trip	
		05	Recovered Undervoltage Trip	
		06	Overvoltage Trip	
		07	Recovered Overvoltage Trip	
		08	Stop Mode	
		09	Flash Error	
		10	External Fault Trip	
		11	IODF Error	
		12	Phase Loss Trip	
		13 – 15	Reserved	
		16	Watch Dog Trip	
		17	Unknown Error	
		18	Data Error	
		19	Key Error	
		20	Memory Module Error	
21	On Board Memory Error			
22	Communication Watchdog Trip			
23	Keypad Stop			
24	Image Revision Error			
25	Image Blank Error			
26	Image Checksum Error			
27	Image HP Code Error			
28	Over Temperature Trip			
29	Recovered Over Temperature			
10.10 **	Communications Error Count	—	—	
10.11 **	Motor Voltage	—	—	
10.12 **	Motor Current	—	—	
10.13 **	Bus Voltage	—	—	
10.14 **	Motor Frequency	—	—	
10.15–10.18	Reserved	—	—	

\*Functions which can only be changed while the drive is in the Stop Mode. \*\*Read only.

**Function Group 11: Advanced Vector Control (Encoder and DIDF Option Board Required)**

Function No.	Description	Range/Code	Factory Setting	User Setting
11.00–1.13	Reserved	—	—	

**Function Group 12: Reserved Functions**

Function No.	Description	Range/Code	Factory Setting	User Setting
12.00–12.09	Reserved	—	—	

---

**APPENDIX A****OPTIONAL IODF INPUT/OUTPUT MULTI-FUNCTION EXPANSION MODULE  
(PART NO. 9646)**

---

The IODF Input/Output Multi-Function Expansion Module provides additional input/output lines to increase the functionality of the standard inputs/outputs of the drive. An additional Multi-Function Output Relay is also provided.

**PRESET FREQUENCIES**

The drive is factory programmed for 7 Preset Frequencies, which can be selected using remote contacts connected to the Multi-Function Input Terminals "1" – "7". See Table 8, on page 37, for the Multi-Function Input Terminals to select for the preset frequencies. The Preset Frequencies can be changed from their factory settings by reprogramming Preset Frequencies 1 – 7 (Functions 7.07 – 7.13). When the contact is closed, the preset frequency is selected. In Figure 26, Multi-Function Input Terminals "1", "2", and "3" have been arbitrarily chosen. As an example, Functions 7.04, 7.05, and 7.06 can also be programmed to use Multi-Function Input Terminals "5", "6", and "7".

The connections for the Multi-Function Output Relay are located on Terminal Block TB3, as shown in Figure 46, on page 66. To access Terminal Block TB2, remove the drive's cover.

The Multi-Function Output Relay is factory programmed to function as a "Run" Relay (Function 5.01 set to "0000"). When the drive is put into the Run Mode, the relay contacts will change state (the Normally Open (N.O.) contact will close and the Normally Closed (N.C.) contact will open). See Table 11.



**TABLE 11**  
**IODF MULTI-FUNCTION OUTPUT RELAY "RUN" AND "FAULT" OPERATING MODES**

Drive Operating Condition	"Run" Relay Mode (Function 5.00 Set to "0000")		"Fault" Relay Mode (Function 5.00 Set to "0001")	
	N.O. Contact	N.C. Contact	N.O. Contact	N.C. Contact
Power Off	Open	Closed	Open	Closed
Power On (Stop Mode)	Open	Closed	Closed	Open
Run Mode	Closed	Open	closed	Open
All Faults	Open	Closed	Open	Closed

**Other Programmable Functions of the Multi-Function Output Relay (Function 5.01)****Code    Description****0000:** Run**0001:** Fault**0002:** Target Frequency (Function 5.03 ± Function 5.04)**0003:** Frequency Threshold Level (>Function 5.03 – Function 5.04)**0004:** Frequency Threshold Level (<Function 5.03 + Function 5.04)**0005:** I<sup>2</sup>t or I-t Fault**0006:** Load Loss (See Function 5.05)**0007:** External Fault



**TABLE 12**  
**IODF INPUT AND OUTPUT CONNECTIONS**

Terminal Block	No.	Description	Specifications
(TB1 on IODF) 	13	Open Collector Output	NPN
	14	MFIT 6	N.O. Contacts or NPN / PNP Transistors 7 Preset Frequencies, Up Frequency Command, Down Frequency Command, Accel/Decel #2, Forward / Stop Command, Reverse / Stop Command, External Fault (N.O. Contact), Reset, N.O. Start (2-Wire or 3-Wire Start/Stop), N.C. Stop (3-Wire Start/Stop), External Fault (N.C. Contact)
	15	MFIT 7	
	16	Common <sup>1</sup>	—
	17	Power Supply	+5 Volts DC at 1 mA Max.
	18	Analog Input #2	0 – 2.5 thru 0 – 25 Volts DC
	19	Common <sup>1</sup>	—
(TB3 on IODF) 	N.O.	Normally Open	Run, Fault, Target Frequency (5.03 ± 5.04), Frequency Threshold Level (> 5.03 – 5.04), Frequency Threshold Level (< 5.03 + 5.04), I <sup>2</sup> t or I•t Fault, Load Loss (See 5.05), External Fault
	COM	Relay Common <sup>2</sup>	
	N.C.	Normally Closed	

**Notes:** 1. Common Terminals 16 and 19 are internally wired together. These terminals are also internally wired to Terminals 4 and 11 on the Drive. 2. Relay Common is not internally wired to Common Terminals 16 and 14 (or Common Terminals 4 and 11 on the Drive).

**TABLE 13**  
**IODF TERMINAL BLOCK WIRE AND TIGHTENING TORQUE SPECIFICATIONS**

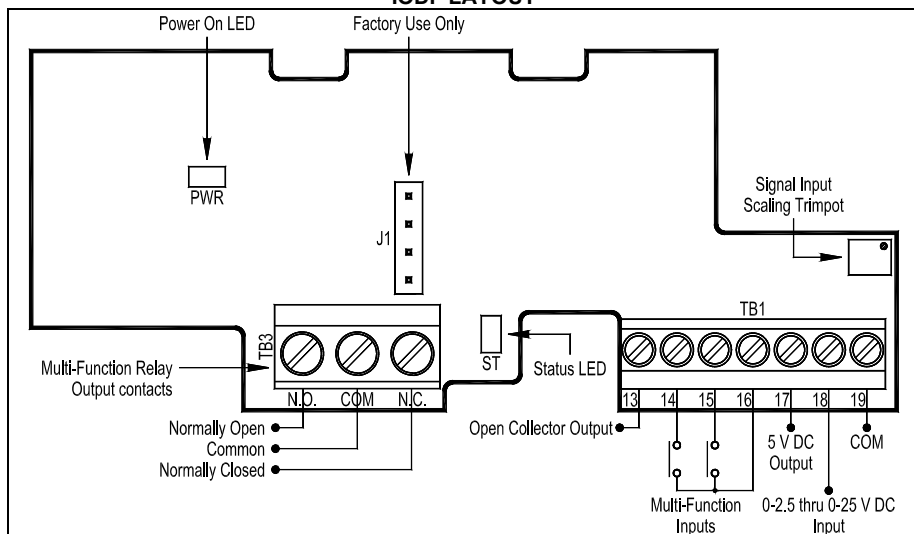
Description	Location	Maximum Wire Size (Cu)		Recommended Tightening Torque	
		AWG	mm <sup>2</sup>	Lbs-in	kg-cm
Multi-Function Input Terminals and Signals In/Out	TB1	16	1.31	1.7	1.9
Multi-Function Output Relay	TB2	16	1.31	2.6	2.9

**TABLE 14**  
**IODF MULTI-FUNCTION INPUT TERMINAL, FUNCTION,**  
**AND FACTORY CODE ASSIGNMENT**

<b>Multi-Function Input Terminal*</b>	6	7
<b>Number On Terminal Block</b>	14	15
<b>Function</b>	7.05	7.06
<b>Factory Code Setting</b>	0003	0004
<b>Code Description</b>	Up Frequency Command	Down Frequency Command

\*Each Multi-Function Input Terminal is controlled by a specific Function. Although factory set to a specific code, they can also be reprogrammed to any code "0000" – "0012" listed in Table 12, on page 65. See Function Group 7, on page 60.

**FIGURE 46**  
**IODF LAYOUT**



### **ANALOG INPUT**

Connect the signal input to Terminal "18" and the common to Terminal "19". Connect the Start (Jumper) to Terminal "9" (ON THE DRIVE), which is factory set for N.O. Start ("0010") and to either common Terminal "4" or "11".

**SCALE Trimpot:** If the input Signal is higher than 25 Volts DC, use the SCALE Trimpot to attenuate it. Apply the maximum signal input and set the drive for full speed output and observe the display. Rotate the SCALE Trimpot counter clockwise until the drive output frequency begins to drop. Then, rotate the SCALE Trimpot clockwise until the display returns to the maximum output frequency.

Set the signal Slope and Type and adjust the Gain, Offset, and Response Time as desired.

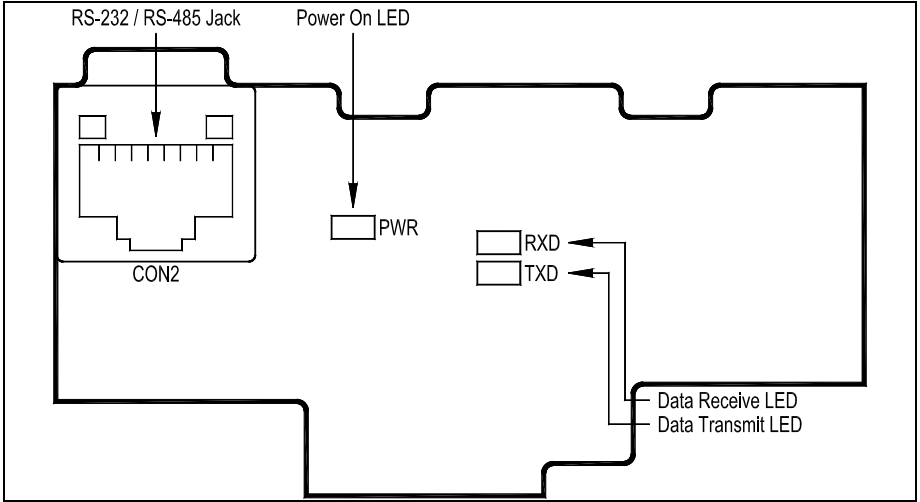
---

**APPENDIX B****OPTIONAL DIDF RS232 AND RS-485 MODBUS RTU COMMUNICATION MODULE****(PART NO. 9647)**

---

The optional DIDF RS-232 and RS-485 Modbus RTU Communication Module allows direct communication between the drive and Modbus RTU protocol. Uses RS-232 and RS-485 Modbus RTU Communication Module. (Required for Drive-Link™.) See Figure 47.

**FIGURE 47**  
**DIDF LAYOUT**



---

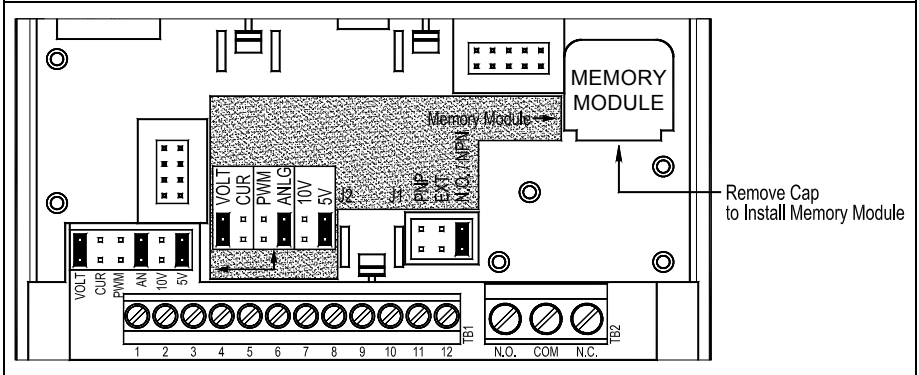
**APPENDIX C**  
**OPTIONAL MEMORY MODULE**  
**(PART NO. 9634)**

---

The optional plug-in memory module can store up to 4 programs for cloning and archiving. This is in addition to the (4) on-board programs. The drive is factory set to use Program 1 on the drive or Memory Module (Function 6.12 set to "0001". For Program 2, Set Function 6.12 to "0002". For Program 3, set Function 6.12 to "0003". For Program 4, set Function 6.12 to "0004".

Remove the cap to install the Memory Module. See Figure 48.

**FIGURE 48**  
**MEMORY MODULE**



**To Copy Program 1 from the Memory Module to the Drive's Active Program**

Press the PROGRAM/DISPLAY Key for 2 seconds (while the drive is in Stop Mode). The drive will read Program 1 from the Memory Module and save it to the Active Program in the drive. "CP-1" will be displayed if the copy was successful.

**To Copy the Drive's Active Program to the Memory Module**

Press the READ/ENTER Key for 5 seconds (while the drive is in Stop Mode). The drive's Active Program will be copied to Program 1 of the Memory Module. "CP-2" will be displayed if the copy was successful.

---

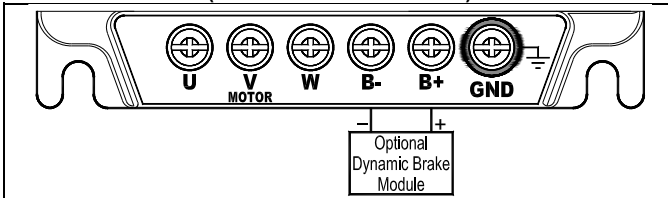
**APPENDIX D**  
**OPTIONAL DYNAMIC BRAKE MODULE**  
**(PART NO. XXXX)**

---

The Dynamic Brake Module Provides dynamic braking of the motor. It is externally mounted. Case "B" drives only.

Connect the positive (+) lead to Terminal "B+" and the negative (-) lead to Terminal "B-". See Figure 49.

**FIGURE 49**  
**DYNAMIC BRAKE MODULE CONNECTION**  
**(CASE "B" DRIVES ONLY)**

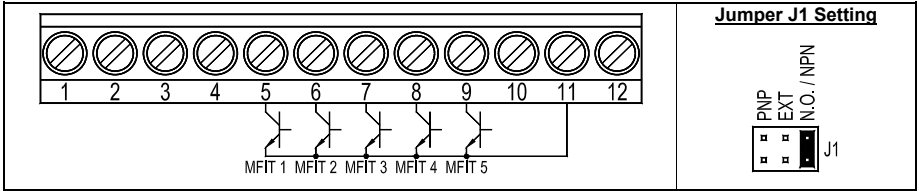


## APPENDIX E

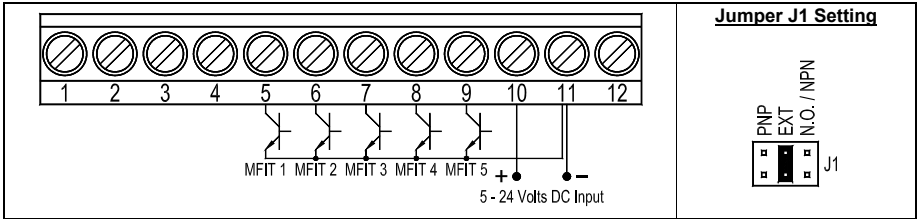
### MULTI-FUNCTION INPUT TERMINALS WITH NPN AND PNP TRANSISTOR CIRCUITS

NPN and PNP transistors can be used for the Multi-function Input Terminals using the internal power supply or an external power supply. See Figures 50 – 53.

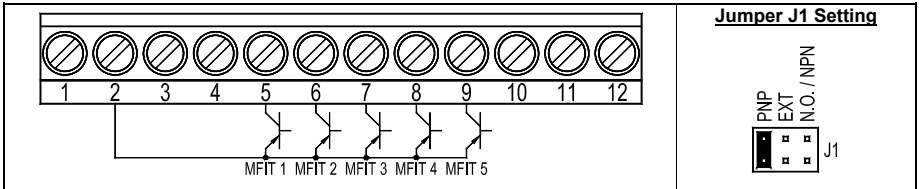
**FIGURE 50**  
**SINKING MODE USING NPN TRANSISTORS WITH INTERNAL POWER SUPPLY CONNECTIONS AND JUMPER J1 SETTING**



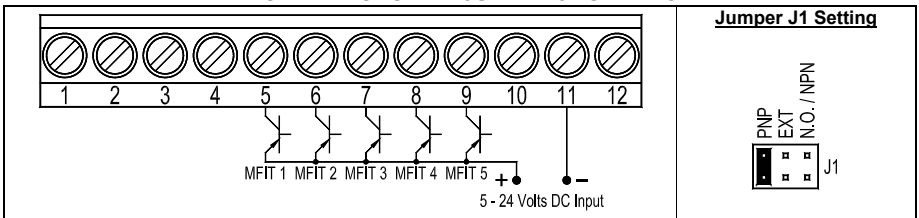
**FIGURE 51**  
**SINKING MODE USING NPN TRANSISTORS WITH EXTERNAL POWER SUPPLY CONNECTIONS AND JUMPER J1 SETTING**



**FIGURE 52**  
**SOURCING MODE USING PNP TRANSISTORS WITH INTERNAL POWER SUPPLY CONNECTIONS AND JUMPER J1 SETTING**



**FIGURE 53**  
**SOURCING MODE USING PNP TRANSISTORS WITH EXTERNAL POWER SUPPLY CONNECTIONS AND JUMPER J1 SETTING**



---

---

## NOTES

---

---

### **LIMITED WARRANTY**

For a period of 18 months from the date of original purchase, KB Electronics, Inc. will repair or replace without charge, devices which our examination proves to be defective in material or workmanship. This warranty is valid if the unit has not been tampered with by unauthorized persons, misused, abused, or improperly installed, and has been used in accordance with the instructions and/or ratings supplied. The foregoing is in lieu of any other warranty or guarantee, expressed or implied. KB Electronics, Inc. is not responsible for any expense, including installation and removal, inconvenience, or consequential damage, including injury to any person, caused by items of our manufacture or sale. Some states do not allow certain exclusions or limitations found in this warranty and therefore they may not apply to you. In any event, the total liability of KB Electronics, Inc., under any circumstance, shall not exceed the full purchase price of this product. (rev. 2/2002)

### **COPYRIGHT © 2012 KB Electronics, Inc.**

All rights reserved. In accordance with the United States Copyright Act of 1976, no part of this publication may be reproduced in any form or by any means without permission in writing from KB Electronics, Inc. (8/2002)



**KB Electronics, Inc.**

12095 NW 39 Street, Coral Springs, FL 33065-2516

Phone: 954-346-4900; Fax: 954-346-3377

Outside Florida call Toll Free: 800-221-6570

E-Mail: [info@kbelectronics.com](mailto:info@kbelectronics.com)

[www.kbelectronics.com](http://www.kbelectronics.com)